

Smart Irrigation,
Create green Lives!

Product
Manual **2024**



企业简介

- 余姚市阳光雨人灌溉设备厂是一家专业的现代化节水灌溉设备、净水设备制造商,目前我们设计制造的产品广泛应用于农业灌溉、园林灌溉、草坪灌溉、企业简介温室大棚灌;工业除尘、畜牧业降温以及灌溉水处理、污水处理等领域。
- 一支优秀的经营团队,20年专业生产制造经验,50几款摇臂喷头的设计制造,与来自几十个国家的国际灌溉品牌公司建立长期稳定的合作关系。在此基础上,阳光雨人设计制造的塑料摇臂喷头、锌合金摇臂喷头、全铜摇臂喷头、金属喷枪、微喷头、压力补偿滴头、纯流滴头、微喷头、地埋式喷头、网式过滤器、叠片式过滤器、塑料取水阀、铜取水阀、塑料电磁阀、铜电磁阀以及各类灌溉系统附件(含减压持压阀、小球阀、排气阀、接头等等),已经畅销国际市场,为诸多国际知名品牌灌溉公司提供了 OEM, ODM 服务。
- 以专业团队的百分百专注,为广大客户提供高品质的产品与服务是我们不懈的追求,我们期待与您建立稳定的合作关系!
- 相信中国! 中国制造! 相信阳光雨人! 让我们携手共创辉煌!

Company Profile

- Yuyao Sun-rainman Irrigation Equipment Factory specializes in producing the irrigation equipments for agriculture irrigation, garden irrigation, landscape irrigation, turf irrigation, greenhouse irrigation, mining dust solution, water treatment and so on
- With a professional manufacturing experience of more than 20years, we have built up a professional team to offer high quality products and services to our customers; Now our products, which are made of high qu ality copper alloy, zinc alloy, and durable engineering plastic, are with exquisite design, advanced technology and reliable quality.
Based on our nonstop-hardworking and good quality products improvements, Sun-rainman have been cooperating with many top brand companies all over the world. Our plastic impact sprinkler, zinc alloy impact sprinkler, brass impact sprinkler, water gun sprayer, micro sprayerpressure compensated dripper, normal dripper, pop-up sprinkler, screen filter, disc filter, plastic quick coupling valve, brass quick couplingvalve, brass quick coupling valve, plastic solenoid valve, br ass solenoid valve and accessories(including pressure reducing valve, pressuresustaining valve,mini valve, air release valve, fittings and so on) have been warmly welcomed in more than76 countries, including the OEM&ODM services for quite a lot of top brand irrigation companies.
- Our designing and developing departments may process products based on your requirement. We sincerely expect to form more and friendly cooperation ship with our clients all over the world.
- Trust China, trust Chinese suppliers, trust SUN-RAIN MAN, we are ready here to do the best services for you!

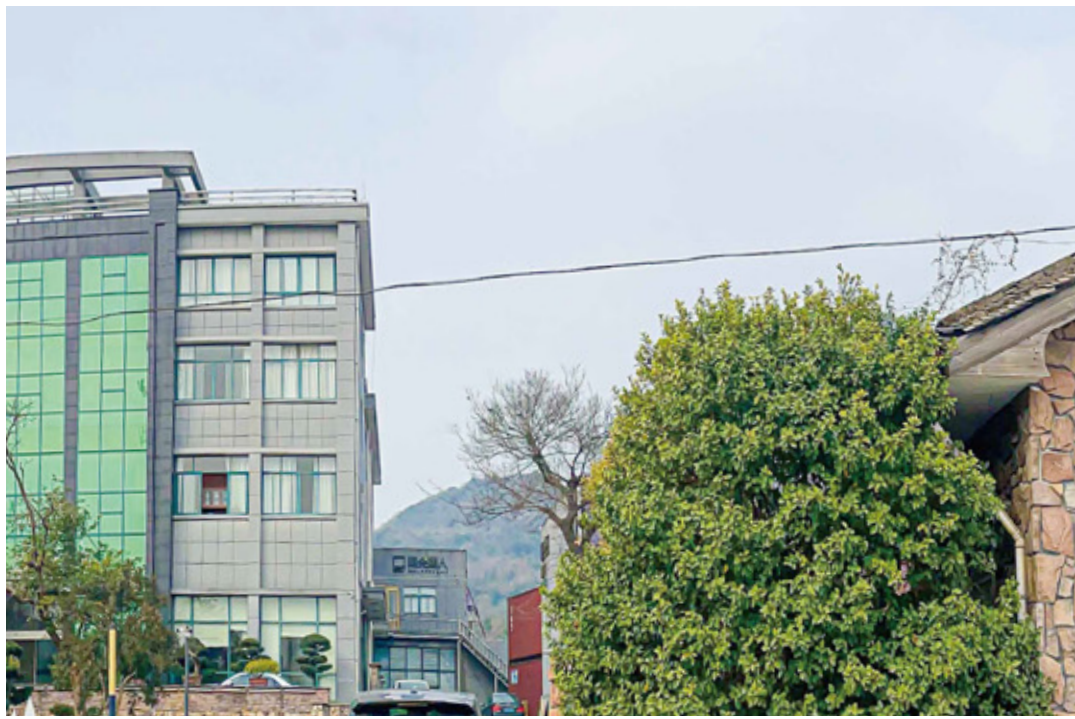

S U N - R A I N M A N

01 - 02

解读阳光雨人
INTERPRETATION

05 - 20

金属摇臂喷头
METAL IMPACT SPRINKLER

21 - 46

塑料臂喷头
PLASTIC IMPACT SPRINKLER

42 - 61

微喷、滴头、连接件
MICRO SPRAYER, DRIPPER,
CONNECTOR

62 - 69

园林灌溉-地理喷头
POP-UP SPRINKLER

70

鞍座
SADDLE CLAMP

企业愿景

- 以给客户提供高品质、高性价比的促进现代化智能灌溉行业和水处理行业发展的产品和服务为盈利基础, 创造一个可持续发展的未来。
- 通过达到或者超过客户的期望值来实现客户的满意度。
- 通过更多的实训和支持实现每一个员工的价值。

MISSION

- Profitably providing high value products and services that promote the smart irrigation and water solution applications , support a sustainable future.
- Achieving customer satisfaction by meeting or exceed customer expectations
- Achieving employees value by more training and supporting.

追求

Profitably providing high value products and services thatm
promote the smart irrigation and water solution applications , support a sustainable future;
Achieving customer satisfaction by meeting or exceed customer expectations;
Achieving employees' value by more training and supporting.

——张建平



S U N - R A I N M A N



ZM8021



OPERATING RANGE

WORKING PRESSURE: 2.0-5.0bar
FLOW RATE: 0.73-4.6m³/h
SPRAY RADIUS: 13.25-18m

APPLICATIONS

1.USAGE

General field use on solid set or fixed irrigation system.

2.FEATURES & BENEFITS

Body Made of ZINC.

Stainless steel parts.

Driver arm & housing & sprindile made of brass

3/4" male pipe thread connection in brass

Dual nozzle design provides outstanding uniformity.

Colour-coded nozzles for easy and quick cleaning or replacement even while operating.

Sand and dust sleeve protection for reliable operation and durability.

Dust and dirt cap protection

PARTS & ACCESSORIES

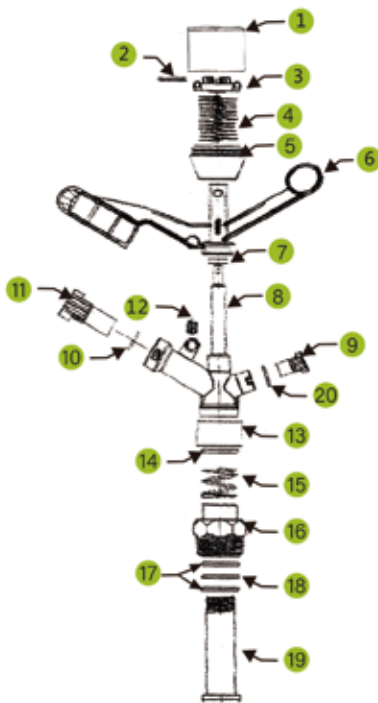

#	Part No.	Material	Qty
1	8021-1	POM	1
2	8021-2	BRASS	1
3	8021-3	POM	1
4	8021-4	SS.304	1
5	8021-5	POM	1
6	8021-6	BRASS	1
7	8021-7	POM	1
8	8021-8	ZINC ALLOY	1
9	8021-9	POM	1
10	8021-10	RUBBER	1
11	8021-11	POM	1
12	8021-12	POM	1
13	8021-13	POM	1
14	8021-14	TEFLON	1
15	8021-15	SS.304	1
16	8021-16	BRASS	1
17	8021-17	RUBBER	2
18	8021-18	TEFLON	1
19	8021-19	BRASS	1
20	8021-20	RUBBER	1

Nozzle specification data sheet

8021 XX XX		
Part No.	Nozzle Size	Nozzle Size
8021	XX	XX
Nozzle Size	Inch	MM
06	3/32"	2.40
08	1/8"	3.20
09	9/64"	3.60
10	5/32"	4.00
11	11/64"	4.30
12	3/16"	4.80
13	13/64"	5.20
14	7/32"	5.60
PG	PLUG	PLUG

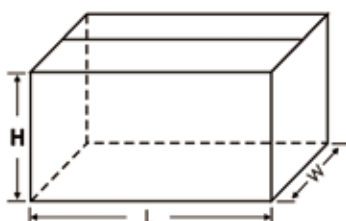

Item#	Qty/ctn	N.W./ctn	G.W./ctn	L x W x H (cm)	M3
ZM8021	50	14.6Kgs	15.22Kgs	40x40x17	0.03



金属臂喷头
METAL IMPACT SPRINKLER

• Performance data

Performance data		3.5x2.5mm Blue			4.0x2.5mm Black			4.5x2.5mm Brown			5.0x2.5mm Purple			5.5x2.5mm Orange		
Nozzle Size	mm															
Pre.	kg/cm ²	3.0	4.0	5.0	3.0	4.0	5.0	3.0	4.0	5.0	3.0	4.0	5.0	3.0	4.0	5.0
Flow Rate	m ³ /h	0.81	0.93	1.02	1.06	1.22	1.35	1.29	1.50	1.65	1.60	1.85	2.10	1.99	2.25	2.50
Rad.	m	13.25	13.75	14.00	14.00	14.50	14.75	14.25	15.00	16.50	15.00	16.75	17.00	16.00	17.25	18.00

Performance data		6.0x2.5mm Red			6.5x2.5mm Grey			6.5x3.2mm Grey			7.0x2.5mm Green			7.0x3.2mm Green		
Nozzle Size	mm															
Pre.	kg/cm ²	3.0	4.0	5.0	3.0	4.0	5.0	3.0	4.0	5.0	3.0	4.0	5.0	3.0	4.0	5.0
Flow Rate	m ³ /h	2.30	2.70	3.00	2.70	3.10	3.50	2.70	3.10	3.50	3.30	3.50	3.90	3.30	3.50	3.90
Rad.	m	16.50	17.75	18.00	17.00	18.00	19.00	17.00	18.00	19.00	17.00	17.50	18.00	17.00	17.50	18.00



ZM8029



OPERATING RANGE

WORKING PRESSURE: 2.0–4.0bar
FLOW RATE: 0.36–1.58m³/h
SPRAY RADIUS: 10.5–13m.

APPLICATIONS

1.USAGE

Designed for agricultural use in solid set.
Can also be used in landscape irrigation;

2.FEATURES

Powder coated zinc die cast construction;
Stainless steel springs and fulcrum pin;
1 / 2 " BSP / NPT male thread , with O-ring;
Dual nozzle design , with a better performance;

PARTS & ACCESSORIES

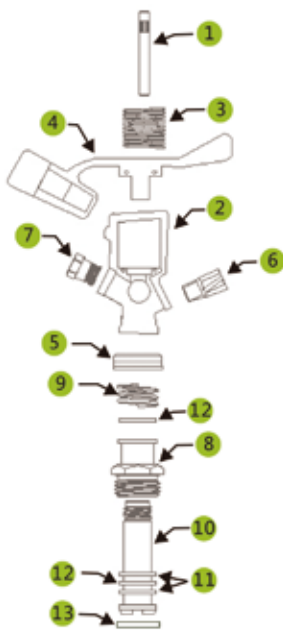

#	Part No.	Material	Qty
1	8029-1	SS304	1
2	8029-2	ZINC ALLOY	1
3	8029-3	SS304	1
4	8029-4	ZINC ALLOY	1
5	8029-5	POM	1
6	8029-6	BRASS	1
7	8029-7	BRASS	1
8	8029-8	BRASS	1
9	8029-9	SS304	1
10	8029-10	BRASS	1
11	8029-11	RUBBER	2
12	8029-12	TEFLON	1
13	8029-13	RUBBER	1

Nozzle specification data sheet

8029 XX XX		
Part No.	Nozzle Size	Nozzle Size
8029	XX	XX
Nozzle Size	Inch	MM
06	3/32"	2.40
08	1/8"	3.20
09	9/64"	3.60
10	5/32"	4.00
PG	PLUG	PLUG

PACKAGING

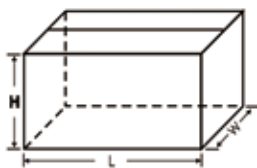

Item#	Qty/ctn	N.W./ctn	G.W./ctn	L x W x H (cm)	M3
ZM8029	75	15.07Kgs	15.46Kgs	48.5x25.5x13	0.018



ZM8015



- OPERATING RANGE

WORKING PRESSURE: 2.0–4.0 bar
FLOW RATE: 0.636–2.256m³/h
SPRAY RADIUS: 11.00–15.50m.

- APPLICATIONS

1.USAGE

Designed for agricultural use in solid set,
Can also be used in landscape irrigation;

2.FEATURES

Solid brass construction;
Stainless steel springs and fulcrum pin;
1 / 2 " BSP / NPT male thread, with O-ring;
Dual nozzle design provides outstanding uniformity;

金属喷头
METAL IMPACT SPRINKLER

- PARTS & ACCESSORIES

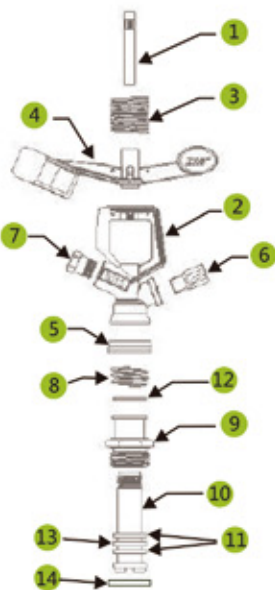

#	Part No.	Material	Qty
1	8015-1	SS304	1
2	8015-2	BRASS	1
3	8015-3	SS304	1
4	8015-4	BRASS	1
5	8015-5	POM	1
6	8015-6	BRASS	1
7	8015-7	BRASS	1
8	8015-8	SS304	1
9	8015-9	BRASS	1
10	8015-10	BRASS	1
11	8015-11	RUBBER	2
12	8015-12	TEFLON	1
13	8015-13	TEFLON	1
14	8015-14	RUBBER	1

Nozzle specification data sheet

8015 XX XX

Part No.	Nozzle Size	Nozzle Size
8015	XX	XX
Nozzle Size	Inch	MM
06	3/32"	2.38
07	7/64"	3.17
08	1/8"	3.57
09	9/64"	3.96
10	5/32"	4.36
PG	PLUG	PLUG

- PACKAGING

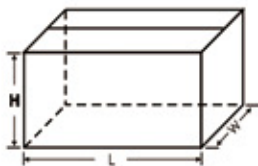

Item#	Qty/ctn	N.W./ctn	G.W./ctn	L x W x H (cm)	M3
ZM8015	75	13.8Kgs	14.15Kgs	42.5x25.5x11.5	0.014

Performance data

Nozzle Size		9/64" X Plug				5/32" X Plug				11/64" X Plug				3/16" X Plug				13/64" X Plug																		
Pre.	kg/cm ²	1.75	2.10	2.45	2.80	3.15	3.50	4.20	1.75	2.10	2.45	2.80	3.15	3.50	4.20	1.75	2.10	2.45	2.80	3.15	3.50	4.20	1.75	2.10	2.45	2.80	3.15	3.50	4.20							
Flow Rate	m ³ /h	0.636	0.696	0.752	0.804	0.853	0.899	0.985	0.782	0.857	0.925	0.989	1.049	1.106	1.210	0.948	1.039	1.122	1.199	1.272	1.341	1.475	1.130	1.238	1.357	1.429	1.516	1.598	1.770	1.323	1.449	1.565	1.673	1.775	1.871	2.150
Rad.	m	11.00	11.00	12.00	12.00	13.00	13.00	13.50	12.00	12.00	13.00	13.50	14.00	14.00	14.50	12.00	13.00	13.50	13.50	14.00	14.00	14.50	13.00	13.50	13.50	14.00	14.00	14.50	15.50	13.50	14.00	14.50	14.50	15.50	16.00	16.50



ZM8028



OPERATING RANGE

WORKING PRESSURE: 2.0-4.0 bar
FLOW RATE: 0.36-1.58m³/h
SPRAY RADIUS: 10.5-13m.

APPLICATIONS

1.USAGE

Designed for agricultural use in solid set,
Can also be used in landscape irrigation,

2.FEATURES

Powder coated zinc die cast construction;
Stainless steel springs and fulcrum pin;
1 / 2 " BSP / NPT male thread with O-ring;
20 to 340 arc or full circle operation;
Anti-tailgate drive arm Stainless steel trip

PARTS & ACCESSORIES

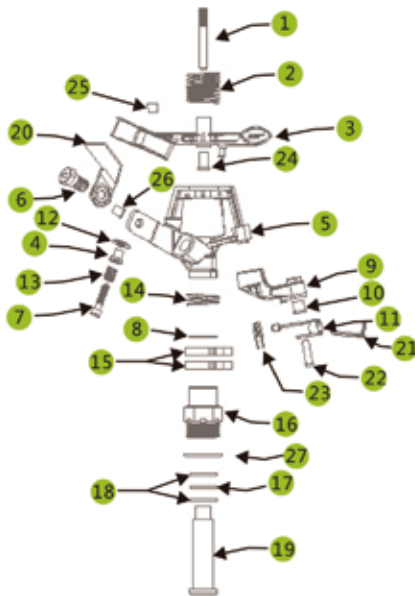

#	Part No.	Material	Qty
1	8028-1	SS304	1
2	8028-2	SS304	1
3	8028-3	ZINC ALLOY	1
4	8028-4	BRASS	1
5	8028-5	ZINC ALLOY	1
6	8028-6	BRASS	1
7	8028-7	SS304	1
8	8028-8	TEFLON	1
9	8028-9	ZINC ALLOY	1
10	8028-10	POM	1
11	8028-11	SS304	1
12	8028-12	SS304	1
13	8028-13	SS304	1
14	8028-14	SS304	1
15	8028-15	SS304	2
16	8028-16	BRASS	1
17	8028-17	TEFLON	1
18	8028-18	RUBBER	2
19	8028-19	BRASS	1
20	8028-20	SS304	1
21	8028-21	SS304	1
22	8028-22	SS304	1
23	8028-23	SS304	1
24	8028-24	POM	1
25	8028-25	RUBBER	1
26	8028-26	BRASS	1
27	8028-27	RUBBER	1

Nozzle specification data sheet

8028 XX XX		
Part No.	Nozzle Size	Nozzle Size
8028	XX	XX
Nozzle Size	Inch	MM
09	9/64"	3.60
10	5/32"	4.00
11	11/64"	4.40
12	3/16"	4.80

PACKAGING

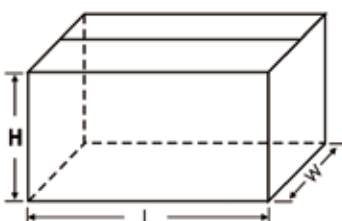

Item#	Qty/ctn	N.W./ctn	G.W./ctn	L x W x H (cm)	M3
ZM8028	32	7.37Kgs	7.95Kgs	46x43x12	0.026

ZM8028



金屬臂噴頭
METAL IMPACT SPRINKLER

Performance data

Nozzle Size	Pre.	PSI	25	30	35	40	45	50	55
		Bars	1.72	2.07	2.41	2.76	3.10	3.45	3.79
3.57mm	Rad.	Feet	33	37	39	42	45	45	46
		Meter	10.06	11.28	11.89	12.80	13.72	13.72	14.02
3.57mm	Flow Rate	GPM	2.79	3.13	3.47	3.74	4.01	4.13	4.17
		L/Min	10.55	11.83	13.12	14.14	15.16	15.61	17.77
3.96mm	Rad.	Feet	35	39	42	43	44	47	48
		Meter	10.67	11.89	12.80	13.11	13.41	14.33	14.63
3.96mm	Flow Rate	GPM	3.54	3.94	4.35	4.62	4.90	5.17	5.44
		L/Min	13.40	14.94	16.49	17.52	18.55	19.58	20.61
4.36mm	Rad.	Feet	37	41	43	45	46	48	48
		Meter	11.28	12.50	13.11	13.72	14.02	14.63	14.63
4.36mm	Flow Rate	GPM	4.22	4.62	5.03	5.37	5.64	6.05	6.39
		L/Min	15.95	17.46	19.01	20.30	21.32	22.87	24.15
4.76mm	Rad.	Feet	37	40	44	45	45	48	48
		Meter	11.28	12.20	13.41	13.72	13.72	14.63	14.63
4.76mm	Flow Rate	GPM	4.96	5.31	5.84	6.32	6.66	7.01	7.34
		L/Min	18.75	20.07	22.08	23.89	25.17	26.50	27.75



ZM8034D



OPERATING RANGE

WORKING PRESSURE: 1.7–5.5 bar
FLOW RATE: 0.66–3.27m³/h
SPRAY RADIUS: 12–17m.

APPLICATIONS

1.USAGE
Designed for agricultural use in solid set,
Can also be used in landscape irrigation

2.FEATURES
Heavy duty brass construction;
Stainless steel springs and fulcrum pin;
3 / 4 " BSP / NPT male thread with O-ring;
Dual nozzle design with a better performance;
Chemically resistant washers;

PARTS & ACCESSORIES

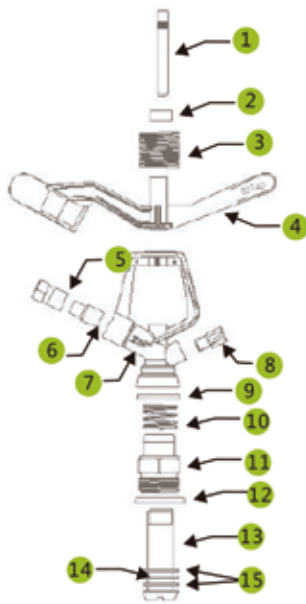

#	Part No.	Material	Qty
1	8034D-1	SS304	1
2	8034D-2	PE	1
3	8034D-3	SS304	1
4	8034D-4	BRASS	1
5	8034D-5	BRASS	1
6	8034D-6	POM	1
7	8034D-7	BRASS	1
8	8034D-8	BRASS	1
9	8034D-9	POM	1
10	8034D-10	SS304	1
11	8034D-11	BRASS	1
12	8034D-12	RUBBER	1
13	8034D-13	BRASS	1
14	8034D-14	TEFLON	1
15	8034D-15	RUBBER	2

Nozzle specification data sheet

8034D XX XX		
Part No.	Nozzle Size	Nozzle Size
8034D	XX	XX
Nozzle Size	Inch	MM
06	3/32"	2.38
08	1/8"	3.17
09	9/64"	3.57
10	5/32"	3.96
11	11/64"	4.36
12	3/16"	4.76
13	13/64"	5.15
14	7/32"	5.55
PG	PLUG	PLUG

PACKAGING

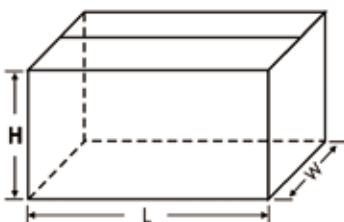

Item#	Qty/ctn	N.W./ctn	G.W./ctn	L x W x H (cm)	M3
ZM8034D	50	18.11Kgs	19.26Kgs	52.5x35x18	0.036

• Performance data

Nozzle Size		9/64" X Plug										5/32" X Plug										11/64" X Plug										3/16" X Plug										13/64" X Plug										7/32" X Plug									
Pre.	kg/cm ²	1.70	2.00	2.50	3.00	3.50	4.00	4.50	5.00	1.70	2.00	2.50	3.00	3.50	4.00	4.50	5.00	1.70	2.00	2.50	3.00	3.50	4.00	4.50	5.00	1.70	2.00	2.50	3.00	3.50	4.00	4.50	5.00	1.70	2.00	2.50	3.00	3.50	4.00	4.50	5.00	1.70	2.00	2.50	3.00	3.50	4.00	4.50	5.00												
Flow Rate	m ³ /h	0.655	0.710	0.790	0.865	0.935	1.000	1.055	1.105	0.800	0.865	0.970	1.060	1.145	1.220	1.290	1.340	0.960	1.040	1.165	1.280	1.380	1.470	1.560	1.625	1.115	1.215	1.365	1.500	1.625	1.740	1.840	1.920	1.315	1.440	1.615	1.770	1.915	2.050	2.170	2.245	1.530	1.670	1.885	2.070	2.245	2.395	2.500	2.560												
Rad.	m	12.50	13.00	13.50	13.75	14.00	14.25	14.50	14.50	13.00	13.50	14.00	14.25	14.50	14.75	15.00	15.00	13.50	14.00	14.50	14.75	15.00	15.25	15.50	15.50	14.00	14.50	15.00	15.25	15.50	15.75	16.00	16.00	14.50	15.00	15.50	15.75	16.00	16.25	16.50	16.75	14.75	15.50	16.00	16.25	16.50	16.75	17.00	17.25												

Nozzle Size		3.57 X 2.38 9/64" X 3/32"										3.96 X 2.38 5/32" X 3/32"										4.36 X 2.38 11/64" X 3/32"										4.76 X 3.17 3/16" X 1/8"										5.15 X 3.17 13/64" X 1/8"										5.55 X 3.17 7/32" X 1/8"									
Pre.	kg/cm ²	1.70	2.00	2.50	3.00	3.50	4.00	4.50	5.00	1.70	2.00	2.50	3.00	3.50	4.00	4.50	5.00	1.70	2.00	2.50	3.00	3.50	4.00	4.50	5.00	1.70	2.00	2.50	3.00	3.50	4.00	4.50	5.00	1.70	2.00	2.50	3.00	3.50	4.00	4.50	5.00	1.70	2.00	2.50	3.00	3.50	4.00	4.50	5.00												
Flow Rate	m ³ /h	0.950	1.030	1.145	1.254	1.355	1.450	1.530	1.602	1.096	1.185	1.329	1.452	1.568	1.671	1.767	1.835	1.246	1.352	1.514	1.664	1.794	1.911	2.028	2.112	1.650	1.798	2.020	2.220	2.405	2.575	2.723	2.840	1.841	2.016	2.261	2.478	2.681	2.870	3.038	3.143	2.065	2.254	2.544	2.794	3.030	3.233	3.375	3.455												
Rad.	m	12.50	13.00	13.50	13.75	14.00	14.25	14.50	14.50	13.00	13.50	14.00	14.25	14.50	14.75	15.00	15.00	13.50	14.00	14.50	14.75	15.00	15.25	15.50	15.50	14.00	14.50	15.00	15.25	15.50	15.75	16.00	16.00	14.50	15.00	15.50	15.75	16.00	16.25	16.50	16.75	14.75	15.50	16.00	16.25	16.50	16.75	17.00	17.25												

金屬噴頭
METAL IMPACT SPRINKLER

ZM8034S



• OPERATING RANGE

WORKING PRESSURE: 1.7–5.5 bar
FLOW RATE: 0.66–3.27m³/h
SPRAY RADIUS: 12–17m.

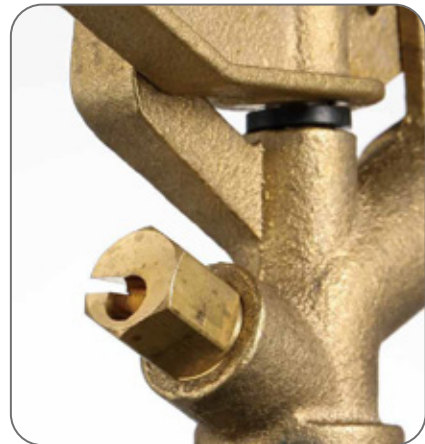

**ZM8041**

- OPERATING RANGE

WORKING PRESSURE: 1.7–5.5 bar
 FLOW RATE: 0.66–3.27m³/h
 SPRAY RADIUS: 12–16m

- APPLICATIONS

1.USAGE

Designed for agricultural use in solid set,
 Can also be used in landscape irrigation;

2.FEATURES

Heavy duty brass construction;
 Stainless steel springs and fulcrum pin;
 3 / 4 " BSP / NPT male thread;
 Dual nozzle design with a better performance;
 20° to 340° arc or full circle operation;
 Stainless steel trip collars ;

- PARTS & ACCESSORIES

#	Part No.	Material	Qty
1	8041-1	SS304	1
2	8041-2	POM	1
3	8041-3	BRASS	1
4	8041-4	BRASS	1
5	8041-5	POM	1
6	8041-6	BRASS	1
7	8041-7	BRASS	1
8	8041-8	BRASS	1
9	8041-9	BRASS	1
10	8041-10	BRASS	1
11	8041-11	BRASS	1
12	8041-12	SS304	1
13	8041-13	SS304	1
14	8041-14	SS304	1
15	8041-15	POM	1
16	8041-16	TEFLON	1
17	8041-17	SS304	2
18	8041-18	SS304	1
19	8041-19	SS304	1
20	8041-20	SS304	1
21	8041-21	SS304	1
22	8041-22	BRASS	1
23	8041-23	BRASS	1
24	8041-24	TEFLON	1
25	8041-25	RUBBER	2

Nozzle specification data sheet

8041 XX XX		
Part No.	Nozzle Size	Nozzle Size
8041	XX	XX
Nozzle Size	Inch	MM
06	3/32"	2.38
08	1/8"	3.17
09	9/64"	3.57
10	5/32"	3.96
11	11/64"	4.36
12	3/16"	4.76
13	13/64"	5.15
14	7/32"	5.55
PG	PLUG	PLUG

- PACKAGING

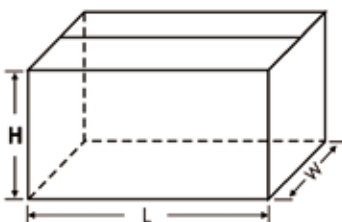

Item#	Qty/ctn	N.W./ctn	G.W./ctn	L x W x H (cm)	M3
ZM8041	24	13.11Kgs	13.72Kgs	43x34x15.5	0.025

ZM8041

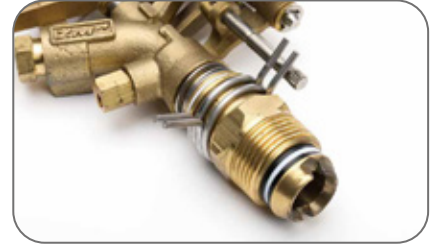

金属摇臂喷头
METAL IMPACT SPRINKLER

Nozzle Size		5/32" X Plug								11/64" X Plug								3/16" X Plug								13/64" X Plug								7/32" X Plug							
Pre.	kg/cm ²	1.75	2.10	2.45	2.80	3.15	3.50	3.85	4.20	1.75	2.10	2.45	2.80	3.15	3.50	3.85	4.20	1.75	2.10	2.45	2.80	3.15	3.50	3.85	4.20	1.75	2.10	2.45	2.80	3.15	3.50	3.85	4.20	1.75	2.10	2.45	2.80	3.15	3.50	3.85	4.20
Flow Rate	m ³ /h	0.795	0.870	0.940	1.010	1.070	1.130	1.185	1.235	0.960	1.050	1.140	1.215	1.290	1.360	1.430	1.480	1.135	1.245	1.355	1.455	1.545	1.630	1.705	1.775	1.835	1.475	1.605	1.725	1.830	1.925	2.010	2.085	1.550	1.715	1.875	2.010	2.135	2.240	2.335	2.405
Rad.	m	12.00	12.00	12.00	13.00	13.00	13.00	14.00	12.00	12.00	13.00	13.00	13.00	14.00	14.00	14.00	12.00	13.00	13.00	13.00	14.00	14.00	14.00	14.00	13.00	13.00	13.00	14.00	14.00	14.00	15.00	13.00	13.00	14.00	14.00	14.00	15.00	15.00	16.00		

Nozzle Size		3.96 X 2.38 5/32" X 3/32"								4.36 X 2.38 11/64" X 3/32"								4.76 X 2.38 3/16" X 3/32"								4.76 X 3.17 3/16" X 1/8"								5.15 X 3.17 13/64" X 1/8"								5.55 X 3.17 7/32" X 1/8"							
Pre.	kg/cm ²	1.75	2.10	2.45	2.80	3.15	3.50	3.85	4.20	1.75	2.10	2.45	2.80	3.15	3.50	3.85	4.20	1.75	2.10	2.45	2.80	3.15	3.50	3.85	4.20	1.75	2.10	2.45	2.80	3.15	3.50	3.85	4.20	1.75	2.10	2.45	2.80	3.15	3.50	3.85	4.20	1.75	2.10	2.45	2.80	3.15	3.50	3.85	4.20
Flow Rate	m ³ /h	1.095	1.190	1.290	1.385	1.470	1.550	1.625	1.690	1.260	1.375	1.490	1.590	1.690	1.785	1.870	1.950	1.430	1.570	1.700	1.830	1.940	2.050	2.145	2.230	1.682	1.848	2.005	2.150	2.290	2.400	2.520	2.630	1.880	2.075	2.255	2.420	2.565	2.700	2.855	2.950	2.095	2.315	2.520	2.700	2.880	3.020	3.155	3.270
Rad.	m	12.50	13.00	13.50	13.50	13.50	14.00	14.00	12.50	13.50	13.50	14.00	14.00	14.50	14.50	14.50	13.00	14.00	14.00	14.50	14.50	15.00	15.00	15.50	13.00	14.00	14.00	14.50	14.50	15.00	15.00	15.50	15.50	16.00	13.50	14.50	15.00	15.50	15.50	16.00	16.00	16.00							



ZM8019



OPERATING RANGE

WORKING PRESSURE: 1.5–4.0 bar
OW RATE: 1.2–3.6m³/h
SPRAY RADIUS: 12–17m.

APPLICATIONS

1.USAGE

Designed for agricultural use in solid set,
Can also be used in landscape irrigation;

2.FEATURES

Powder coated aluminium die cast construction;
Stainless steel springs and fulcrum pin;
1" BSP / NPT female thread;
With brass diffuser screw offer a better performance;
20° to 340° arc or full circle operation;



PARTS & ACCESSORIES

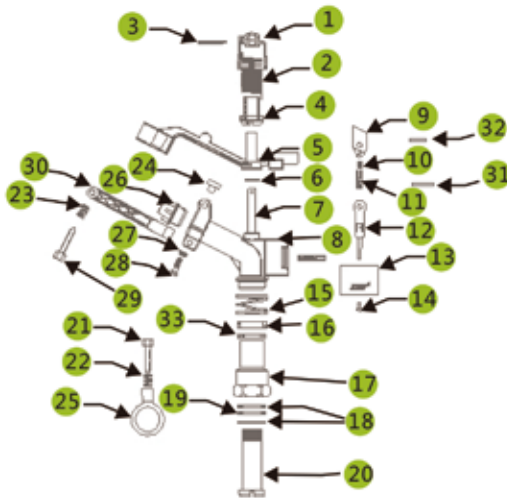

#	Part No.	Material	Qty
1	8019-1	NILON	1
2	8019-2	SS304	1
3	8019-3	SS304	1
4	8019-4	NILON	1
5	8019-5	BRASS	1
6	8019-6	TEFLON	1
7	8019-7	SS304	1
8	8019-8	ALUMINOY	1
9	8019-9	NILON	1
10	8019-10	SS304	1
11	8019-11	BRASS	1
12	8019-12	NILON	1
13	8019-13	NILON	1
14	8019-14	SS304	1
15	8019-15	SS304	1
16	8019-16	POM	1
17	8019-17	BRASS	1
18	8019-18	RUBBER	2
19	8019-19	TEFLON	1
20	8019-20	BRASS	1
21	8019-21	BRASS	2
22	8019-22	SS304	2
23	8019-23	SS304	1
24	8019-24	NILON	1
25	8019-25	NILON	2
26	8019-26	POM	1
27	8019-27	SS304	1
28	8019-28	SS304	1
29	8019-29	BRASS	1
30	8019-30	NILON	1
31	8019-31	SS304	1
32	8019-32	SS304	1
33	8019-33	TEFLON	1

8019 XX		
Part No.	Nozzle Size	Nozzle Size
8019	XX	
Nozzle Size	Inch	MM
13	13/64"	5.00
15	15/64"	6.00
18	9/32"	7.00

PACKAGING

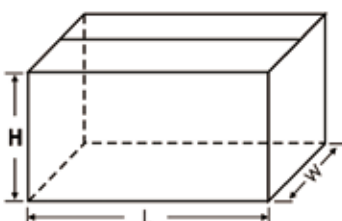

Item#	Qty/ctn	N.W./ctn	G.W./ctn	L x W x H (cm)	M3
ZM8019	20	13.1Kgs	15.25Kgs	57x48x25	0.07

ZM8019



金屬臂噴頭
METAL IMPACT SPRINKLER

Nozzle Size		13/64" (5.00mm)				15/64" (6.00mm)				9/32" (7.00mm)			
Pre.	bar	1.5	2	3	4	1.5	2	3	4	1.5	2	3	4
Rad.	m	12	13	14	16	13	14	15	16.5	13.5	14.5	16	17
Flow Rate	L/m	20	22	27	32	28	32	39	45	37	42	52	60
	m ³ /h	1.2	1.3	1.6	1.9	1.7	1.9	2.3	2.7	2.2	2.5	3.1	3.6



ZM8065



OPERATING RANGE

WORKING PRESSURE: 2.0–6.0 bar
FLOW RATE: 5.1–24.8m³/h
SPRAY RADIUS: 16–29m.

APPLICATIONS

1.USAGE

Designed for agricultural use in solid set;
Can also be used in landscape Irrigation;

2.FEATURES

Powder coated aluminium die cast construction
Stainless steel springs and fulcrum pin
1.5" BSP / NPT Female thread brass connector
Dual nozzle design with a better performance;
Dual brass diffuser screw offer a better performance;

PARTS & ACCESSORIES

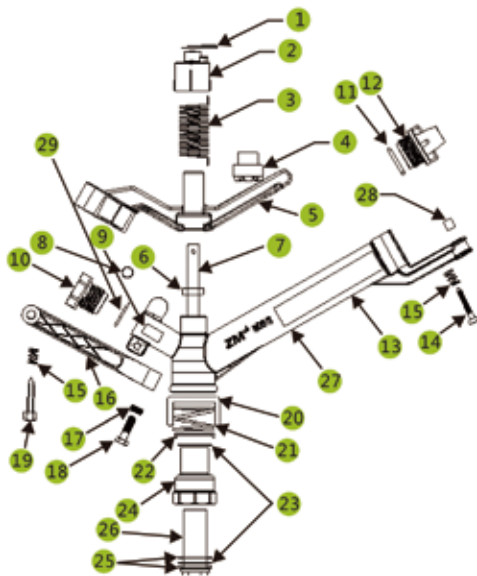

#	Part No.	Material	Qty
1	8065-1	SS304	1
2	8065-2	NYLON	1
3	8065-3	SS304	1
4	8065-4	NYLON	1
5	8065-5	BRASS	1
6	8065-6	TEFLON	1
7	8065-7	SS304	1
8	8065-8	NYLON	1
9	8065-9	POM	1
10	8065-10	POM	1
11	8065-11	RUBBER	1
12	8065-12	POM	1
13	8065-13	POM	1
14	8065-14	BRASS	1
15	8065-15	SS304	1
16	8065-16	NYLON	1
17	8065-17	SS304	1
18	8065-18	SS304	1
19	8065-19	BRASS	1
20	8065-20	NYLON	1
21	8065-21	SS304	1
22	8065-22	POM	1
23	8065-23	NYLON	2
24	8065-24	BRASS	1
25	8065-25	RUBBER	2
26	8065-26	BRASS	1
27	8065-27	ALALLOY	1
28	8065-28	BRASS	1

8065 XX XX		
Part No.	Nozzle Size	Nozzle Size
8065	XX	XX
Nozzle Size	Inch	MM
18	9/32"	7.0
20	5/16"	8.0
25	25/64"	10.0
30	15/32"	12.0
35	35/64"	14.0
40	5/8"	16.0

PACKAGING

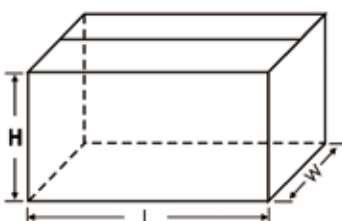

Item#	Qty/ctn	N.W./ctn	G.W./ctn	L x W x H (cm)	M3
ZM8065	10	13Kgs	14Kgs	58x39x24	0.06

ZM8065



金屬臂噴頭
METAL IMPACT SPRINKLER

ZM8067



Nozzle Size		9/32" x 5/16" (7.0 x 8.0mm)				9/32" x 25/64" (7.0 x 10.0mm)				9/32" x 15/32" (7.0 x 12.0mm)				9/32" x 35/64" (7.0 x 14.0mm)				13/64" x 5/8" (7.0 x 16.0mm)			
Pre.	kg/cm ²	2	3	4	5	2	3	4	5	2	3	4	5	2	3	4	5	2	3	4	5
Flow Rate	m ³ /h	5.1	5.9	7.2	8.4	7.8	9.5	11.0	12.4	10.1	12.4	14.3	16.1	12.9	15.8	18.3	20.5	16.0	19.6	22.7	24.8
Rad.	m	16.0	17.5	19.5	21.0	18.0	21.0	23.0	24.5	19.5	22.0	25.0	27.5	20.5	23.5	26.0	28.5	21.0	24.0	26.5	29.0



ZM8066



OPERATING RANGE

WORKING PRESSURE: 2.0–6.0 bar
FLOW RATE: 5.1–24.8m³/h
SPRAY RADIUS: 16–29m.

APPLICATIONS

1.USAGE

Designed for agricultural use in solid set;
Can also be used in landscape Irrigation;

2.FEATURES

Powder coated aluminium die cast construction;
Stainless steel springs and fulcrum pin;
1.5" BSP / NPT Female thread;
Dual nozzle design with a better performance;
Brass diffuser pin offer a better uniformity;

PARTS & ACCESSORIES

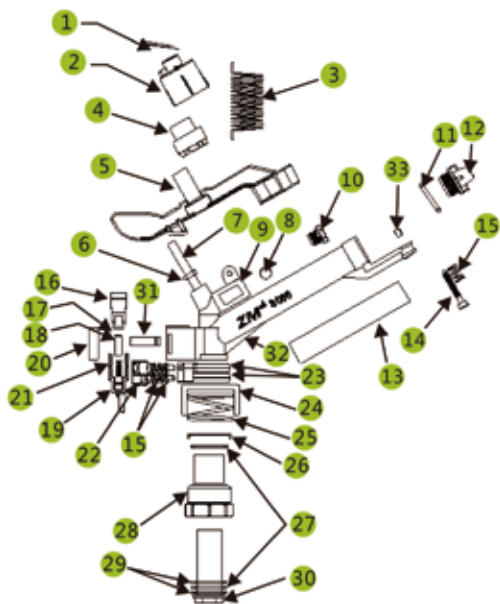

#	Part No.	Material	Qty
1	8066-1	SS304	1
2	8066-2	NYLON	1
3	8066-3	SS304	1
4	8066-4	NYLON	1
5	8066-5	BRASS	1
6	8066-6	TEFLON	1
7	8066-7	SS304	1
8	8066-8	NYLON	1
9	8066-9	POM	1
10	8066-10	POM	1
11	8066-11	RUBBER	1
12	8066-12	POM	1
13	8066-13	POM	1
14	8066-14	BRASS	1
15	8066-15	SS304	3
16	8066-16	POM	1
17	8066-17	BRASS	1
18	8066-18	BRASS	1
19	8066-19	NYLON	1
20	8066-20	NYLON	1
21	8066-21	NYLON	1
22	8066-22	SS304	2
23	8066-23	POM	2
24	8066-24	POM	1
25	8066-25	SS304	1
26	8066-26	POM	1
27	8066-27	TEFLON	2
28	8066-28	BRASS	1
29	8066-29	RUBBER	2
30	8066-30	BRASS	1
31	8066-31	SS304	1
32	8066-32	ALALLOY	1
33	8066-33	BRASS	1

Nozzle specification data sheet

8066 XX XX		
Part No.	Nozzle Size	Nozzle Size
8066	XX	XX
Nozzle Size	英寸 Inch	MM
18	9/32"	7.0
20	5/16"	8.0
25	25/64"	10.0
30	15/32"	12.0
35	35/64"	14.0
40	5/8"	16.0

PACKAGING

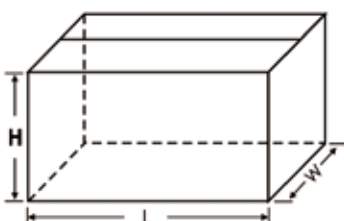

Item#	Qty/ctn	N.W./ctn	G.W./ctn	L x W x H (cm)	M3
ZM8066	10	15.8Kgs	16.9Kgs	58x39x24	0.06

ZM8066



金屬臂噴頭
METAL IMPACT SPRINKLER

ZM8068



Nozzle Size		9/32" x 5/16" (7.0 x 8.0mm)				9/32" x 25/64" (7.0 x 10.0mm)				9/32" x 15/32" (7.0 x 12.0mm)				9/32" x 35/64" (7.0 x 14.0mm)				13/64" x 5/8" (7.0 x 16.0mm)			
Pre.	kg/cm ²	2	3	4	5	2	3	4	5	2	3	4	5	2	3	4	5	2	3	4	5
Flow Rate	m ³ /h	5.1	5.9	7.2	8.4	7.8	9.5	11.0	12.4	10.1	12.4	14.3	16.1	12.9	15.8	18.3	20.5	16.0	19.6	22.7	24.8
Rad.	m	16.0	17.5	19.5	21.0	18.0	21.0	23.0	24.5	19.5	22.0	25.0	27.5	20.5	23.5	26.0	28.5	21.0	24.0	26.5	29.0



ZM8501



OPERATING RANGE

WORKING PRESSURE: 1.0–3.0 bar
 FLOW RATE: 0.08–0.27m³/ h
 SPRAY RADIUS: 4.25–7.5m.

APPLICATIONS

1.USAGE
 Designed for agricultural use in solid set,
 Can also be used in landscape irrigation

2.FEATURES
 Made of plastic debris;
 Turbo hammer mechanism provides excellent
 water distribution uniformity and smooth operation
 at low pressure rate;
 Colour-coded nozzles for easy identification;
 High impact heavy-duty plastic materials provide
 resistance to corrosion ,
 1/2"Male thread or 1/2"Female thread

PARTS & ACCESSORIES

Nozzle specification data sheet

8501 XX		
Part No.	Nozzle Size	Nozzle Size
8501	XX	XX
Nozzle Size	Inch	MM
04	1/16"	1.60
05	5/64"	1.80
#50	0.07"	2.00
#44	0.086"	2.20

PACKAGING

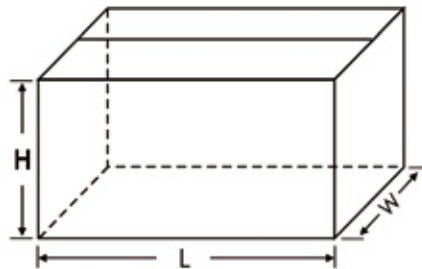

Item#	Qty/ctn	N.W./ctn	G.W./ctn	L x W x H (cm)	M3
ZM8501	200	6.53Kgs	7.13Kgs	40x40x17	0.03

Performance data

Nozzle Size	mm	1.6 (Red)			1.8* (Green)			2.0 (Blue)			2.2 (Yellow)		
		1.0	2.0	3.0	1.0	2.0	3.0	1.0	2.0	3.0	1.0	2.0	3.0
Pre.	kg/cm ²	1.0	2.0	3.0	1.0	2.0	3.0	1.0	2.0	3.0	1.0	2.0	3.0
Flow Rate	m ³ /h	0.081	0.117	0.144	0.113	0.16	0.196	0.135	0.195	0.236	0.153	0.22	0.267
Rad.	m	4.25	5.50	6.00	4.50	5.75	6.25	4.75	5.75	6.50	4.75	6.50	7.50



ZM8503



OPERATING RANGE

WORKING PRESSURE: 2.5–4.0 bar
 FLOW RATE: 0.36–0.82m³/h
 SPRAY RADIUS: 8.25–10.5m.

APPLICATIONS

1.USAGE

Designed for agricultural use in solid set,
 Can also be used in landscape irrigation

2.FEATURES

Made of plastic debris;
 Extra-range, ball driven sprinkler;
 Compact , Sturdy closed protected ball engine;
 Colour-coded bayonet nozzles for easy identification;
 High water distribution;
 High impact heavy-duty plastic materials provide
 resistance to corrosion . chemicals and UV
 1/2" Male thread

PARTS & ACCESSORIES

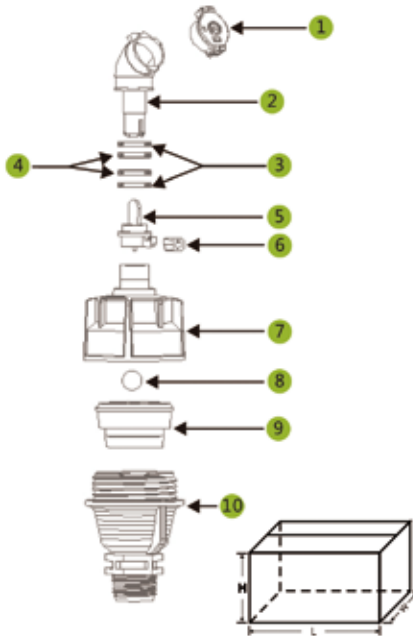

#	Part No.	Material	Qty
1	8503-1	POM	1
2	8503-2	POM	1
3	8503-3	RUBBER	2
4	8503-4	CERAMIC	2
5	8503-5	NYLON	1
6	8503-6	RUBBER	1
7	8503-7	POM	1
8	8503-8	S.S.304	1
9	8503-9	PP	1
10	8503-10	POM	1

Nozzle specification data sheet

8503 XX	
Part No.	Nozzle Color
8503	XX
NOZZLE CODE	Colour
N1	Blue
N2	Yellow
N3	Green
N4	Red
N5	Brown

Item#	Qty/ctn	N.W./ctn	G.W./ctn	L x W x H (cm)	M3
ZM8503	250	8.97Kgs	9.47Kgs	47x35x25	0.045

Performance data

Nozzle Color		Blue				Yellow				Green				Red			
		2.5	3.0	3.5	4.0	2.5	3.0	3.5	4.0	2.5	3.0	3.5	4.0	2.5	3.0	3.5	4.0
Pre.	bar																
Flow Rate	m ³ /h	0.360	0.395	0.425	0.455	0.450	0.495	0.530	0.570	0.550	0.600	0.650	0.695	0.670	0.710	0.770	0.820
Dia.	m	17.0	17.0	16.5	16.5	20.0	20.0	20.0	20.0	20.0	20.0	20.0	20.0	21.0	21.0	21.0	21.0

Brown nozzle for road protector only

Nozzle Color		Brown			
Pre.	bar	2.5	3.0	3.5	4.0
Flow Rate	m ³ /h	0.320	0.350	0.380	0.405
Dia.	m	16	16	16	16



ZM8504



OPERATING RANGE

WORKING PRESSURE: 2.0-4.0 bar
 FLOW RATE: 0.15-0.36m³/h
 SPRAY RADIUS: 6.7-8.5m.

APPLICATIONS

1.USAGE

Designed for agricultural use in solid set,
 Can also be used in landscape irrigation

2.FEATURES

Made of plastic debris;
 Compact, Sturdy closed protected ball engine
 Uniform water distribution at low pressure and precipitation rate
 Colour-coded low trajectory nozzles for easy operation and service; insect pop-up, pop-down nozzle;

塑料喷头
 PLASTIC IMPACT SPRINKLER

PARTS & ACCESSORIES

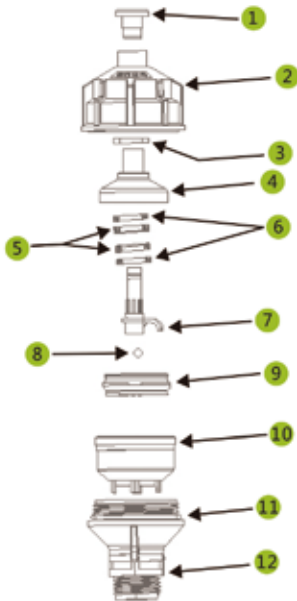

#	Part No.	Material	Qty
1	8504-1	POM	1
2	8504-2	POM	1
3	8504-3	RUBBER	1
4	8504-4	PP	1
5	8504-5	CERAMIC	2
6	8504-6	RUBBER	2
7	8504-7	NYLON	1
8	8504-8	S.S.304	1
9	8504-9	PP	1
10	8504-10	POM	1
11	8504-11	RUBBER	1
12	8504-12	POM	1

Nozzle specification data sheet

8504 XX	
Part No.	Nozzle Color
8504	XX
Colour	
N1	Blue
N2	Yellow
N3	Purple
N4	Black

PACKAGING

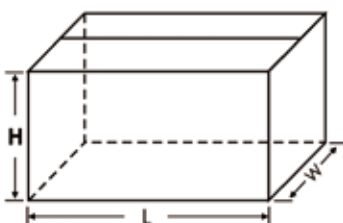

Item#	Qty/ctn	N.W./ctn	G.W./ctn	L x W x H (cm)	M3
ZM8504	250	9.37Kgs	9.99Kgs	40x40x17	0.03



塑料管喷头
PLASTIC IMPACT SPRINKLER

• Performance data

Nozzle Color	Blue			Yellow		
	Pre. (bar)	2.0	3.0	4.0	2.0	3.0
Flow Rate (m ³ /h)	0.150	0.170	0.190	0.190	0.220	0.260
Dia (m)	13.4	14.0	14.6	13.6	15.6	15.8

• Brown nozzle for road protector only

Nozzle Color	Purple			Black		
	Pre. (bar)	2.0	3.0	4.0	2.0	3.0
Flow Rate (m ³ /h)	0.260	0.300	0.340	0.280	0.320	0.360
Dia (m)	14.0	16.0	17.0	14.4	16.4	16.4



ZM8022



OPERATING RANGE

WORKING PRESSURE: 2.0–4.0 bar
FLOW RATE: 0.36–1.58m³/ h
SPRAY RADIUS: 10.25–12.75m.

APPLICATIONS

1.USAGE
Designed for agricultural use in solid set,
Can also be used in landscape irrigation;

2.FEATURES
Made of plastic debris;
Stainless steel springs and fulcrum pin
Dual nozzle design provides outstanding uniformity
Colour-coded nozzles for easy and quick cleaning
or replacement even while operating;



PARTS & ACCESSORIES

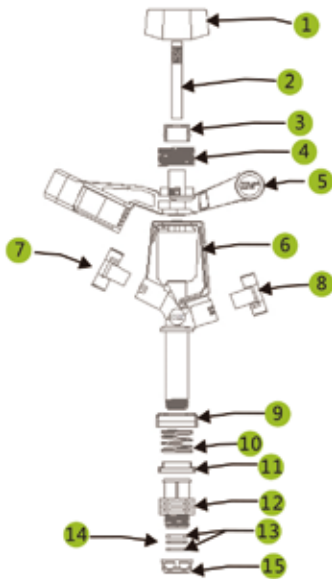

#	Part No.	Material	Qty
1	8022-1	PP	1
2	8022-2	SS304	1
3	8022-3	POM	1
4	8022-4	SS304	1
5	8022-5	POM	1
6	8022-6	POM	1
7	8022-7	POM	1
8	8022-8	POM	1
9	8022-9	POM	1
10	8022-10	SS304	1
11	8022-11	NYLON	1
12	8022-12	POM	1
13	8022-13	RUBBER	2
14	8022-14	TEFLON	1
15	8022-15	POM	1

Nozzle specification data sheet

8022 XX XX		
Part No.	Nozzle Size	Nozzle Size
8022	XX	XX
Nozzle Size	Inch	MM
#50	0.07"	1.80
#44	0.086"	2.30
06 ^S	0.095"	2.40
06	3/32"	2.50
07	7/64"	2.80
06 ⁺	0.118"	3.00
08	1/8"	3.20
09	9/64"	3.50
10	5/32"	4.00
PG	堵头	plug

PACKAGING

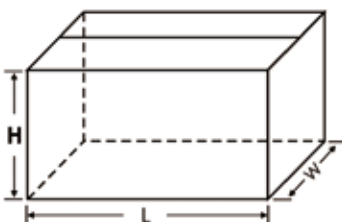

Item#	Qty/ctn	N.W./ctn	G.W./ctn	L x W x H (cm)	M3
ZM8022	75	3.8Kgs	4.2Kgs	48.5x25.5x13	0.018

• Performance data

Nozzle Size	mm	2.3×1.8 (Grey)		2.5×1.8 (Purple)		2.8×1.8 (Orange)		3.0×1.8 (Red)		3.2×1.8 (Green)		3.5×2.5 (Blue)		4.0×2.5 (Black)	
		Pre.	bar	2.5	3.0	2.5	3.0	2.5	3.0	2.5	3.0	2.5	3.0	2.5	3.0
Flow Rate	m ³ /h	0.510	0.580	0.580	0.630	0.690	0.760	0.760	0.840	0.820	0.900	1.060	1.160	1.260	1.380
Rad.	m	11.00	11.00	10.50	10.50	11.00	11.00	11.00	11.50	11.50	12.00	12.25	12.50	12.50	12.75

Nozzle Size	mm	2.3×1.8 (Grey)		2.5×1.8 (Purple)		2.8×1.8 (Orange)		3.0×1.8 (Red)		3.2×1.8 (Green)		3.5×2.5 (Blue)		4.0×2.5 (Black)	
		Pre.	bar	3.5	4.0	3.5	4.0	3.5	4.0	3.5	4.0	3.5	4.0	3.5	4.0
Flow Rate	m ³ /h	0.600	0.640	0.670	0.720	0.820	0.860	0.900	0.970	0.980	1.040	1.240	1.330	1.480	1.580
Rad.	m	11.00	11.00	10.50	10.75	11.00	11.00	11.50	11.50	12.00	12.00	12.75	13.00	13.00	13.25

Nozzle Size	mm	2.3 (Grey)			2.4 (Square, Yellow)				2.5 (Purple)			2.8 (Orange)			3.0 (Red)			3.2 (Green)			3.5 (Blue)			4.0 (Black)		
		Pre.	bar	2.0	3.0	4.0	2.5	3.0	3.5	4.0	2.0	3.0	4.0	2.0	3.0	4.0	2.0	3.0	4.0	2.0	3.0	4.0	2.0	3.0	4.0	
Flow Rate	m ³ /h	0.330	0.390	0.460	0.360	0.390	0.430	0.460	0.350	0.430	0.490	0.450	0.550	0.630	0.510	0.530	0.720	0.570	0.700	0.810	0.660	0.810	0.930	0.850	1.030	1.180
Rad.	m	10.75	11.00	11.00	9.50	9.50	10.00	10.50	10.75	11.00	11.00	11.00	11.50	12.00	11.50	12.25	12.50	11.75	12.25	12.50	12.50	13.00	13.00	12.00	13.00	13.00

塑料喷头
PLASTIC IMPACT SPRINKLER

• ZM8022N



• ZM8022SD



• OPERATING RANGE

WORKING PRESSURE: 2.0–4.0 bar
FLOW RATE: 0.36–1.58m³/h
SPRAY RADIUS: 10.25–12.75m.

• OPERATING RANGE

WORKING PRESSURE: 2.0–4.0 bar
FLOW RATE: 0.36–1.58m³/h
SPRAY RADIUS: 10.25–12.75m.



ZM8023



OPERATING RANGE

WORKING PRESSURE: 2.0-4.0 bar
FLOW RATE: 0.35-0.93m³/h
SPRAY RADIUS: 8.25-11.00m.

APPLICATIONS

1.USAGE

Designed for agricultural use in solid set,
Can also be used in landscape irrigation;

2.FEATURES

Made of plastic debris;
Stainless steel springs and fulcrum pin
Colour-coded nozzles for easy and quick cleaning
or replacement even while operating
Low angle design special for banana irrigation;
1/2" Male thread

农业灌溉-金属摇臂喷头
METAL IMPACT SPRINKLER

PARTS & ACCESSORIES

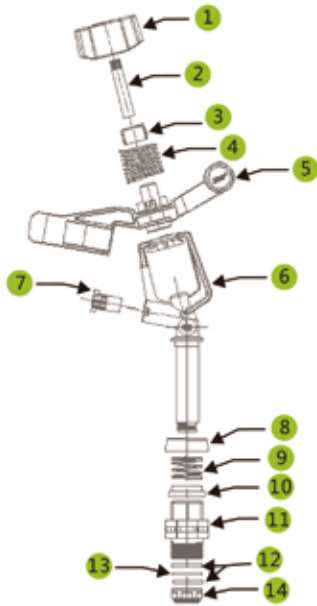

#	Part No.	Material	Qty
1	8023-1	PP	1
2	8023-2	SS.304	1
3	8023-3	POM	1
4	8023-4	SS.304	1
5	8023-5	POM	1
6	8023-6	POM	1
7	8023-7	POM	1
8	8023-8	POM	1
9	8023-9	SS.304	1
10	8023-10	NYLON	1
11	8023-11	POM	1
12	8023-12	RUBBER	2
13	8023-13	TEFLON	1
14	8023-14	POM	1

Nozzle specification data sheet

8023 XX XX		
Part No.	Nozzle Size	Nozzle Size
8023	XX	XX
Nozzle Size	Inch	MM
06	3/32"	2.50
07	7/64"	2.80
07*	0.118"	3.00
08	1/8"	3.20
09	9/64"	3.50

PACKAGING

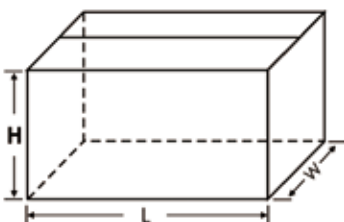

Item#	Qty/ctn	N.W./ctn	G.W./ctn	L x W x H (cm)	M3
ZM8023	75	3.9Kgs	4.3Kgs	48.5x25.5x13	0.018

• Performance data

Nozzle	mm	2.5 Purple			2.8* Orange			3.0 Red			3.2 Green			3.5 Blue		
		2.0	3.0	4.0	2.0	3.0	4.0	2.0	3.0	4.0	2.0	3.0	4.0	2.0	3.0	4.0
Pre.	bar	2.0	3.0	4.0	2.0	3.0	4.0	2.0	3.0	4.0	2.0	3.0	4.0	2.0	3.0	4.0
Flow Rate	m ³ /h	0.35	0.43	0.49	0.45	0.55	0.63	0.51	0.63	0.72	0.57	0.70	0.81	0.66	0.81	0.93
Rad.	m	8.25	9.25	10.00	9.25	10.00	10.50	9.25	10.25	10.75	9.25	10.25	11.00	9.25	10.25	11.00

ZM8023SD



• OPERATING RANGE

WORKING PRESSURE: 2.0–4.0 bar
 FLOW RATE: 0.35–0.93m³/h
 SPRAY RADIUS: 8.25–11.00m.

• APPLICATIONS

1.USAGE

Designed for agricultural use in solid set,
 Can also be used in landscape irrigation;

2.FEATURES

Made of plastic debris;
 Stainless steel springs and fulcrum pin
 Colour-coded nozzles for easy and quick cleaning
 or replacement even while operating
 Low angle design special for banana irrigation;

塑料臂喷头
 PLASTIC IMPACT SPRINKLER



ZM8024



OPERATING RANGE

WORKING PRESSURE: 2.0–4.0 bar
FLOW RATE: 0.48–1.0m³/h
SPRAY RADIUS: 9.25–11.75m.

APPLICATIONS

1.USAGE

Designed for agricultural use in solid set,
Can also be used in landscape irrigation;

2.FEATURES

Made of plastic debris;
Stainless steel springs and fulcrum pin
High resistance to breakage, corrosion and UV radiation
12' for optimum irrigation of the plantation,
without wetting the fruit;
Colour-coded bayonet nozzle for easy operation

PARTS & ACCESSORIES

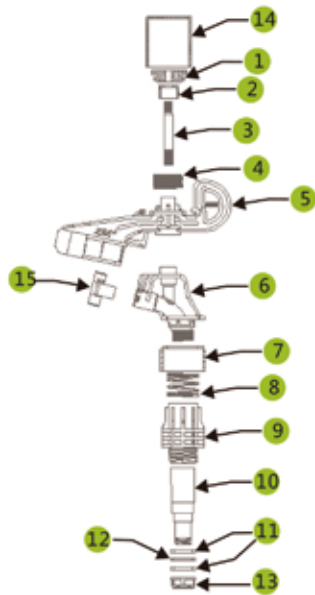

#	Part No.	Material	Qty
1	8024-1	POM	1
2	8024-2	POM	1
3	8024-3	S.S.304	1
4	8024-4	S.S.304	1
5	8024-5	POM	1
6	8024-6	POM	1
7	8024-7	POM	1
8	8024-8	S.S.304	1
9	8024-9	POM	1
10	8024-10	POM	1
11	8024-11	RUBBER	2
12	8024-12	TERLON	1
13	8024-13	POM	1
14	8024-14	POM	1
15	8024-15	POM	1

Nozzle specification data sheet

8024 XX XX		
Part No.	Nozzle Size	Nozzle Size
8024	XX	XX
Nozzle Size	Inch	MM
07	7/64"	2.80
07 ⁺	0.118"	3.00
08	1/8"	3.20
09	9/64"	3.50

PACKAGING

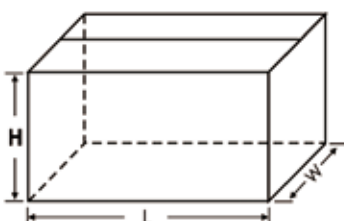

Item#	Qty/ctn	N.W./ctn	G.W./ctn	L x W x H (cm)	M3
ZM8024	50	3.88Kgs	4.28Kgs	53x28x13.5	0.022

• Performance data

Nozzle Size	2.8mm (Orange)					
Pre.	Bar	2.0	2.5	3.0	3.5	4.0
Flow Rate	m ³ /h	0.480	0.530	0.584	0.630	0.675
Rad.	mts.	9.25	9.75	10.25	10.5	10.5

喷嘴直径 Nozzle Size	3.0mm (Red)					
水压 Pre.	Bar	2.0	2.5	3.0	3.5	4.0
流量 Flow Rate	m ³ /h	0.525	0.585	0.640	0.695	0.745
喷洒半径 Rad.	mts.	9.75	10.50	10.50	11.00	11.25

Nozzle Size	3.2mm (Green)					
Pre.	Bar	2.0	2.5	3.0	3.5	4.0
Flow Rate	m ³ /h	0.570	0.640	0.700	0.765	0.815
Rad.	mts.	10.00	10.50	11.00	11.25	11.75

Nozzle Size	3.5mm (Blue)					
Pre.	Bar	2.0	2.5	3.0	3.5	4.0
Flow Rate	m ³ /h	0.68	0.76	0.86	0.96	1.01
Rad.	mts.	10.50	10.75	11.50	11.75	11.75

ZM8024SD



• OPERATING RANGE

WORKING PRESSURE: 2.0–4.0 bar
FLOW RATE: 0.35–0.93m³/h
SPRAY RADIUS: 9.25–11.75m.

• APPLICATIONS

1.USAGE

Designed for agricultural use in solid set,
Can also be used in landscape irrigation;

2.FEATURES

Made of plastic debris;
Stainless steel springs and fulcrum pin
High resistance to breakage, corrosion and UV radiation
I2 for optimum irrigation of the plantation,
without wetting the fruit;
Colour-coded bayonet nozzle for easy operation



ZM8427



OPERATING RANGE

WORKING PRESSURE: 2.0-4.0 bar
FLOW RATE: 0.45-1.03m³/ h
SPRAY RADIUS: 11-13m.

APPLICATIONS

1.USAGE

Designed for agricultural use in solid set,
Can also be used in landscape irrigation

2.FEATURES

Made of plastic debris;
Stainless steel springs and fulcrum pin
20 to 340 arc or full circle operation
Anti-backsplash drive arm;
Adjustable deflector plate;
20 to 340 arc or full circle operation



PARTS & ACCESSORIES

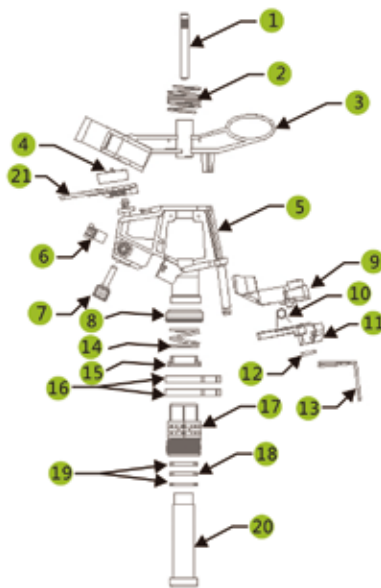

#	Part No.	Material	Qty
1	8427-1	SS304	1
2	8427-2	SS304	1
3	8427-3	POM	1
4	8427-4	POM	1
5	8427-5	POM	1
6	8427-6	POM	1
7	8427-7	POM	1
8	8427-8	POM	1
9	8427-9	POM	1
10	8427-10	SS304	1
11	8427-11	POM	1
12	8427-12	POM	1
13	8427-13	SS304	1
14	8427-14	SS304	1
15	8427-15	NYLON	1
16	8427-16	POM	2
17	8427-17	POM	1
18	8427-18	TEFLON	1
19	8427-19	RUBBER	2
20	8427-20	POM	1
21	8427-21	POM	1

Nozzle specification data sheet

8427 XX XX		
Part No.	Nozzle Size	Nozzle Size
8427	XX	XX
Nozzle Size	Inch	MM
07	7/64"	2.80
07 ⁺	0.118"	3.00
08	1/8"	3.20
09	9/64"	3.50
10	5/32"	4.00

PACKAGING

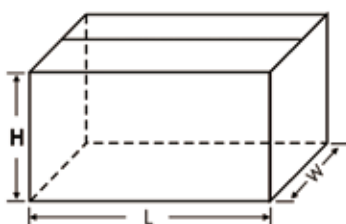

Item#	Qty/ctn	N.W./ctn	G.W./ctn	L x W x H (cm)	M3
ZM8427	50	4.39Kgs	5.06Kgs	49x38x14	0.03



塑料管喷头
PLASTIC IMPACT SPRINKLER

• Performance data

Nozzle Size	mm	2.8 (Orange)			3.0 (Red)			3.2 (Green)			3.5 (Blue)			4.0 (Black)		
		2.0	3.0	4.0	1.0	2.0	3.0	1.0	2.0	3.0	1.0	2.0	3.0	1.0	2.0	3.0
Pre.	bar	2.0	3.0	4.0	1.0	2.0	3.0	1.0	2.0	3.0	1.0	2.0	3.0	1.0	2.0	3.0
Flow Rate	m ³ /h	0.45	0.55	0.63	0.36	0.51	0.63	0.41	0.57	0.70	0.49	0.66	0.81	0.60	0.85	1.03
Rad.	m	11.0	11.5	12.0	9.50	11.5	12.0	10.0	11.5	12.0	10.0	11.5	12.0	10.5	12.0	13.0



ZM8035



OPERATING RANGE

WORKING PRESSURE: 3.0–5.0 bar
FLOW RATE: 0.73–4.6m³/h
SPRAY RADIUS: 13.25–18m.

APPLICATIONS

1.USAGE

Designed for agricultural use in solid set,
Can also be used in landscape irrigation;

2.FEATURES

Made of plastic debris;
Stainless steel springs and fulcrum pin
3/4" heavy-duty plastic impact sprinkler
Dual nozzle design provides outstanding uniformity;
Colour-coded nozzles for easy and quick cleaning
or replacement even while operating

PARTS & ACCESSORIES

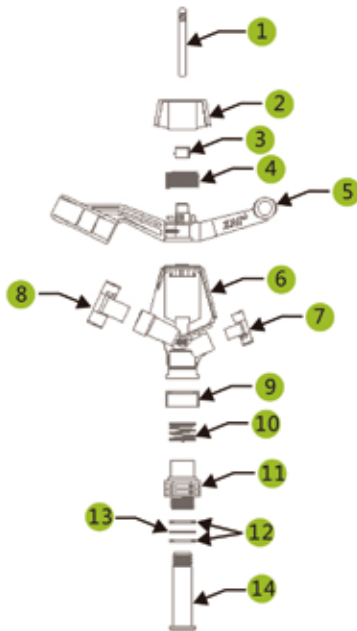

#	Part No.	Material	Qty
1	8035-1	SS304	1
2	8035-2	POM	1
3	8035-3	POM	1
4	8035-4	SS304	1
5	8035-5	POM	1
6	8035-6	POM	1
7	8035-7	POM	1
8	8035-8	POM	1
9	8035-9	POM	1
10	8035-10	SS304	1
11	8035-11	POM	1
12	8035-12	RUBBER	2
13	8035-13	TEFLON	1
14	8035-14	POM	1

Nozzle specification data sheet

8035 XX XX		
Part No.	Nozzle Size	Nozzle Size
8035	XX	XX
Nozzle Size	Inch	MM
06	3/32"	2.50
08	1/8"	3.20
09	9/64"	3.50
10	5/32"	4.00
11	11/64"	4.50
13	13/64"	5.00
14	7/32"	5.50
15	15/64"	6.00
16	1/4"	6.50
18	9/32"	7.00
PG	PLUG'	PLUG

PACKAGING

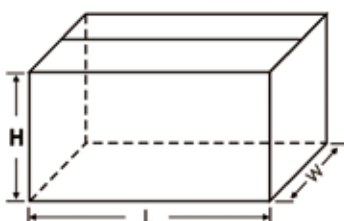

Item#	Qty/ctn	N.W./ctn	G.W./ctn	L x W x H (cm)	M3
ZM8035	50	6Kgs	6.5Kgs	40x40x17	0.03

• Performance data

Nozzle Size	mm	3.5×2.5 蓝色(Blue)			4.0×2.5 黑色(Black)			4.5×2.5 棕色(Brown)			5.0×2.5 ⁺ 紫色(Purple)			5.5×2.5 橘色(Orange)		
		3.0	4.0	5.0	3.0	4.0	5.0	3.0	4.0	5.0	3.0	4.0	5.0	3.0	4.0	5.0
Pre.	bar	3.0	4.0	5.0	3.0	4.0	5.0	3.0	4.0	5.0	3.0	4.0	5.0	3.0	4.0	5.0
Flow Rate (Q1)	m ³ /h	0.81	0.93	1.02	1.06	1.22	1.35	1.29	1.50	1.65	1.60	1.85	2.10	1.95	2.25	2.50
Flow Rate (Q2)	m ³ /h	1.16	1.33	1.47	1.41	1.62	1.80	1.64	1.90	2.10	1.95	2.25	2.55	2.30	2.65	2.95
Rad.	m	13.25	13.75	14.00	14.00	14.50	14.75	14.25	15.00	16.50	15.00	16.75	17.00	16.00	17.25	18.00

Nozzle Size	mm	6.0×2.5 红色(Red)			6.5×2.5 灰色(Grey)			6.5×3.2 灰色(Grey)			7.0×2.5 绿色(Green)			7.0×3.2 绿色(Green)		
		3.0	4.0	5.0	3.0	4.0	5.0	3.0	4.0	5.0	3.0	4.0	5.0	3.0	4.0	5.0
Pre.	bar	3.0	4.0	5.0	3.0	4.0	5.0	3.0	4.0	5.0	3.0	4.0	5.0	3.0	4.0	5.0
Flow Rate (Q1)	m ³ /h	2.30	2.70	3.00	2.70	3.10	3.50	2.70	3.10	3.50	3.30	3.50	3.90	3.30	3.50	3.90
Flow Rate (Q2)	m ³ /h	2.65	3.10	3.45	3.00	3.45	3.85	3.20	3.70	4.15	3.40	3.90	4.35	3.55	4.10	4.60
Rad.	m	16.50	17.75	18.00	17.00	18.00	19.00	17.00	18.00	19.00	17.00	17.50	18.00	17.10	17.80	18.00

(Q1-Single nozzle(w/o rear noz.))
(Q2-Dual nozzles)

• ZM8035M



• OPERATING RANGE

WORKING PRESSURE: 3.0–5.0 bar
FLOW RATE: 0.73–4.6m³/h
SPRAY RADIUS: 13.25–18.00m.

• ZM8035SD



• OPERATING RANGE

WORKING PRESSURE: 3.0–5.0 bar
FLOW RATE: 0.73–4.6m³/h
SPRAY RADIUS: 13.25–18.00m.



ZM8035PC



OPERATING RANGE

WORKING PRESSURE: 3.0–5.0 bar
FLOW RATE: 0.73–3.0m³/h
SPRAY RADIUS: 13.25–18m.

APPLICATIONS

1.USAGE

Designed for agricultural use in solid set,
Can also be used in landscape irrigation;

2.FEATURES

Made of plastic debris;
Stainless steel springs and fulcrum pin
3/4" heavy-duty plastic impact sprinkler
Dual nozzle design provides outstanding uniformity;
Colour-coded nozzles for easy and quick cleaning
or replacement even while operating;
Part circle coverage

PARTS & ACCESSORIES

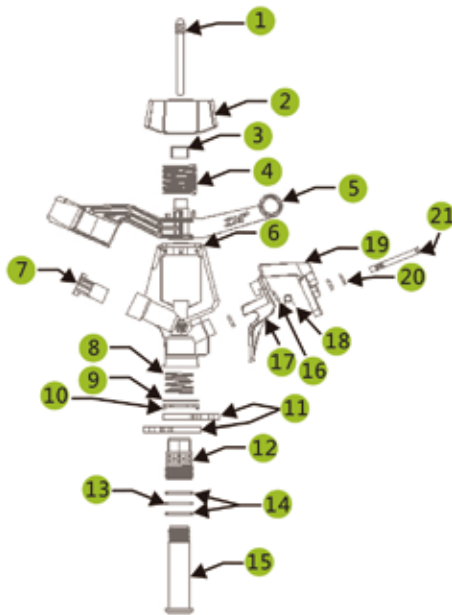

#	Part No.	Material	Qty
1	8035PC-1	SS304	1
2	8035PC-2	PP	1
3	8035PC-3	POM	1
4	8035PC-4	SS304	1
5	8035PC-5	POM	1
6	8035PC-6	POM	1
7	8035PC-7	POM	1
8	8035PC-8	SS304	1
9	8035PC-9	SS304	1
10	8035PC-10	TEFLON	1
11	8035PC-11	POM	2
12	8035PC-12	POM	1
13	8035PC-13	TEFLON	1
14	8035PC-14	RUBBER	2
15	8035PC-15	POM	1
16	8035PC-16	ALALLOY	3
17	8035PC-17	PP	1
18	8035PC-18	SS304	1
19	8035PC-19	PP	1
20	8035PC-20	SS304	1
21	8035PC-21	SS304	1

Nozzle specification data sheet

8035PC XX XX		
Part No.	Nozzle Size	Nozzle Size
8035PC	XX	XX
Nozzle Size	Inch	MM
09	9/64"	3.50
10	5/32"	4.00
11	11/64"	4.50
13	13/64"	5.00
14	7/32"	5.50
15	15/64"	6.00

PACKAGING

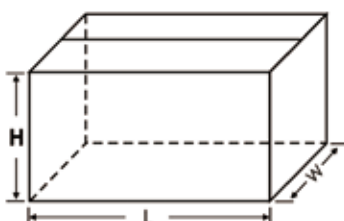

Item#	Qty/ctn	N.W./ctn	G.W./ctn	L x W x H (cm)	M3
ZM8035PC	40	6Kgs	6.63Kgs	40x40x17	0.03



• Performance data

Nozzle Size	mm	3.5 (Blue)			4.0 (Black)			4.5 (Brown)			5.0 (Purple)			5.5 (Orange)			6.0 (Red)		
		3.0	4.0	5.0	3.0	4.0	5.0	3.0	4.0	5.0	3.0	4.0	5.0	3.0	4.0	5.0	3.0	4.0	5.0
Pre.	bar	3.0	4.0	5.0	3.0	4.0	5.0	3.0	4.0	5.0	3.0	4.0	5.0	3.0	4.0	5.0	3.0	4.0	5.0
Flow Rate	m ³ /h	0.81	0.93	1.02	1.06	1.22	1.35	1.29	1.50	1.65	1.60	1.85	2.10	1.95	2.25	2.50	2.30	2.70	3.00
Rad.	m	13.25	13.75	14.0	14.0	14.5	14.75	14.25	15.0	16.5	15.0	16.75	17.0	16.0	17.25	18.0	16.5	17.25	18.0

• ZM8035PCSD



• OPERATING RANGE

WORKING PRESSURE: 3.0–5.0 bar
FLOW RATE: 0.73–3.0m³/h
SPRAY RADIUS: 13.25–18m.

• APPLICATIONS

1.USAGE

Designed for agricultural use in solid set,
Can also be used in landscape irrigation;

2.FEATURES

Made of plastic debris;
Stainless steel springs and fulcrum pin
3/4" heavy-duty plastic impact sprinkler
Dual nozzle design provides outstanding uniformity;
Colour-coded nozzles for easy and quick cleaning
or replacement even while operating;
Part circle coverage



ZM8036



OPERATING RANGE

WORKING PRESSURE: 1.75–4.2 bar
OW RATE: 0.8–4.6m³/h
SPRAY RADIUS: 13.25–18m.

APPLICATIONS

1.USAGE

Designed for agricultural use in solid set,
Can also be used in landscape irrigation;

2.FEATURES

Made of plastic debris;
Stainless steel springs and fulcrum pin
3/4" heavy-duty plastic impact sprinkler
Dual nozzle design provides outstanding uniformity;
Colour-coded nozzles for easy and quick cleaning
or replacement even while operating;
Part circle coverage

PARTS & ACCESSORIES

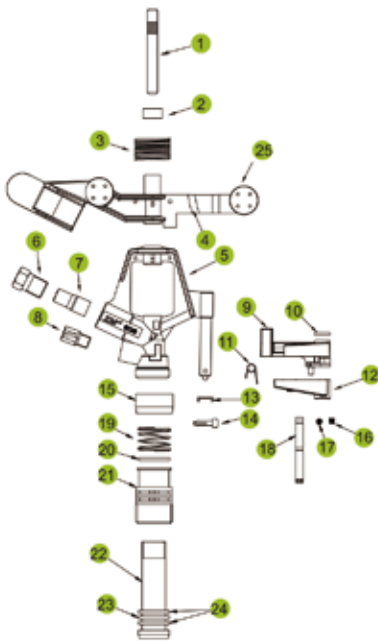

#	Part No.	Material	Qty
1	8036-1	SS304	1
2	8036-2	PE	1
3	8036-3	SS304	1
4	8036-4	POM	1
5	8036-5	POM	1
6	8036-6	BRASS	1
7	8036-7	POM	1
8	8036-8	BRASS	1
9	8036-9	POM	1
10	8036-10	POM	1
11	8036-11	SS304	1
12	8036-12	POM	1
13	8036-13	POM	1
14	8036-14	POM	1
15	8036-15	POM	1
16	8036-16	SS304	1
17	8036-17	SS304	1
18	8036-18	SS304	1
19	8036-19	SS304	1
20	8036-20	TEFLON	1
21	8036-21	POM	1
22	8036-22	POM	1
23	8036-23	TEFLON	1
24	8036-24	RUBBER	2
25	8036-25	METAL	1

Nozzle specification data sheet

8036 XX XX		
Part No.	Nozzle Size	Nozzle Size
8036	XX	XX
Nozzle Size	Inch	MM
06	3/32"	2.40
08	1/8"	3.20
09	9/64"	3.60
10	5/32"	4.00
11	11/64"	4.30
12	3/16"	4.80
13	13/64"	5.20
14	7/32"	5.60
PG	PLUG	PLUG

PACKAGING

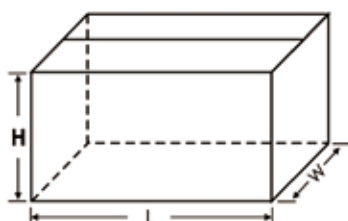

Item#	Qty/ctn	N.W./ctn	G.W./ctn	L x W x H (cm)	M3
ZM8036	40	7.67Kgs	8.22Kgs	40x40x17	0.03



塑料管喷头
 PLASTIC IMPACT SPRINKLER

• Performance data

Nozzle Size	Bars	1.75	2.10	2.46	3.16	3.51	4.21
9/64"-3.57mm	m ³ /h	0.66	0.72	0.77	0.87	0.92	0.99
	mts.	26.2	27.0	27.6	28.4	28.8	29.4
5/32"-3.96mm	m ³ /h	0.80	0.87	0.94	1.07	1.13	1.23
	mts.	27.8	28.8	29.4	30.2	30.6	31.2
11/64"-4.36mm	m ³ /h	0.96	1.05	1.14	1.29	1.36	1.49
	mts.	29.4	30.0	30.6	31.4	33.0	32.4
3/16"-4.76mm	m ³ /h	1.14	1.25	1.36	1.55	1.63	1.78
	mts.	30.0	31.0	31.0	32.0	33.0	33.0
13/64"-5.15mm	m ³ /h	1.34	1.48	1.61	1.83	1.93	2.09
	mts.	30.8	31.4	32.0	33.2	33.8	34.8
7/32"-5.55mm	m ³ /h	1.55	1.72	1.88	2.14	2.24	2.41
	mts.	31.2	32.0	33.0	34.8	35.6	36.8

Nozzle Size	Bars	1.75	2.10	2.46	3.16	3.51	4.21
9/64"-3.57mm	m ³ /h	0.92	1.00	1.09	1.25	1.33	1.44
	mts.	26.0	26.6	27.2	28.2	28.4	29.0
5/32"-3.96mm	m ³ /h	1.10	1.20	0.94	1.47	1.55	1.70
	mts.	27.6	28.4	29.4	30.0	30.2	30.8
11/64"-4.36mm	m ³ /h	1.25	1.38	1.14	1.69	1.79	1.95
	mts.	29.0	29.6	30.6	31.2	31.4	32.0
3/16"-4.76mm	m ³ /h	1.68	1.85	1.36	2.29	2.41	2.63
	mts.	29.0	30.0	31.0	32.0	32.0	33.0
13/64"-5.15mm	m ³ /h	1.88	2.08	1.61	2.57	2.70	2.95
	mts.	30.2	30.8	32.0	32.6	33.2	34.2
7/32"-5.55mm	m ³ /h	2.10	2.32	1.88	2.88	3.02	3.27
	mts.	30.6	31.4	33.0	34.2	35.0	36.2



ZM8037



OPERATING RANGE

WORKING PRESSURE: 2.0–5.0 bar
FLOW RATE: 0.73–4.6m³/h
SPRAY RADIUS: 13.25–18m.

APPLICATIONS

1.USAGE

General field use on solid set or fixed irrigation system.

2.FEATURES & BENEFITS

Made of plastic debris;
Stainless steel parts.
3/4" Heavy-duty plastic impact sprinkler
3/4" male pipe thread connection.
Nozzles available in plastic or brass.
Dual nozzle design provides outstanding uniformity.
Sand and dust sleeve protection for reliable operation and durability.

PARTS & ACCESSORIES

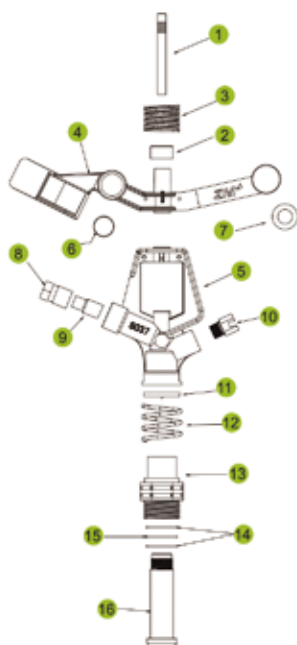

#	Part No.	Material	Qty
1	8037-1	SS304	1
2	8037-2	PE	1
3	8037-3	SS304	1
4	8037-4	POM	1
5	8037-5	POM	1
6	8037-6	METAL	1
7	8037-7	METAL	1
8	8037-8	BRASS	1
9	8037-9	POM	1
10	8037-10	BRASS	1
11	8037-11	POM	1
12	8037-12	SS304	1
13	8037-13	POM	1
14	8037-14	RUBBER	1
15	8037-15	TEFLOW	1
16	8037-16	POM	1

Nozzle specification data sheet

8037 XX XX		
Part No.	Nozzle Size	Nozzle Size
8037	XX	XX
Nozzle Size	Inch	MM
06	3/32"	2.40
08	1/8"	3.20
09	9/64"	3.60
10	5/32"	4.00
11	11/64"	4.30
12	3/16"	4.80
13	13/64"	5.20
14	7/32"	5.60
PG	PLUG	PLUG

PACKAGING

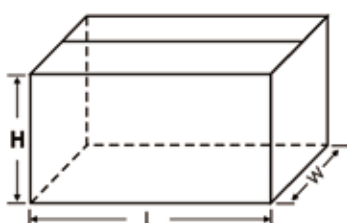

Item#	Qty/ctn	N.W./ctn	G.W./ctn	L x W x H (cm)	M3
ZM8037	50	7.95Kgs	8.57Kgs	40x40x17	0.03



• Performance data

Nozzle Size	Bars	1.75	2.10	2.46	3.16	3.51	4.21
9/64"-3.57mm	m ³ /h	0.66	0.72	0.77	0.87	0.92	0.99
	mts.	26.2	27.0	27.6	28.4	28.8	29.4
5/32"-3.96mm	m ³ /h	0.80	0.87	0.94	1.07	1.13	1.23
	mts.	27.8	28.8	29.4	30.2	30.6	31.2
11/64"-4.36mm	m ³ /h	0.96	1.05	1.14	1.29	1.36	1.49
	mts.	29.4	30.0	30.6	31.4	33.0	32.4
3/16"-4.76mm	m ³ /h	1.14	1.25	1.36	1.55	1.63	1.78
	mts.	30.0	31.0	31.0	32.0	33.0	33.0
13/64"-5.15mm	m ³ /h	1.34	1.48	1.61	1.83	1.93	2.09
	mts.	30.8	31.4	32.0	33.2	33.8	34.8
7/32"-5.55mm	m ³ /h	1.55	1.72	1.88	2.14	2.24	2.41
	mts.	31.2	32.0	33.0	34.8	35.6	36.8

Nozzle Size	Bars	1.75	2.10	2.46	3.16	3.51	4.21
9/64"-3.57mm	m ³ /h	0.92	1.00	1.09	1.25	1.33	1.44
	mts.	26.0	26.6	27.2	28.2	28.4	29.0
5/32"-3.96mm	m ³ /h	1.10	1.20	0.94	1.47	1.55	1.70
	mts.	27.6	28.4	29.4	30.0	30.2	30.8
11/64"-4.36mm	m ³ /h	1.25	1.38	1.14	1.69	1.79	1.95
	mts.	29.0	29.6	30.6	31.2	31.4	32.0
3/16"-4.76mm	m ³ /h	1.68	1.85	1.36	2.29	2.41	2.63
	mts.	29.0	30.0	31.0	32.0	32.0	33.0
13/64"-5.15mm	m ³ /h	1.88	2.08	1.61	2.57	2.70	2.95
	mts.	30.2	30.8	32.0	32.6	33.2	34.2
7/32"-5.55mm	m ³ /h	2.10	2.32	1.88	2.88	3.02	3.27
	mts.	30.6	31.4	33.0	34.2	35.0	36.2



ZM8051



OPERATING RANGE

WORKING PRESSURE: 3.0–5.0 bar
 OW RATE: 0.73–4.6m³/h
 SPRAY RADIUS: 13.25–18m.

APPLICATIONS

1.USAGE

Designed for agricultural use in solid set,
 Can also be used in landscape irrigation;

2.FEATURES

Made of plastic debris;
 Stainless steel parts.
 3/4" heavy-Duty plastic impact sprinkler.
 Nozzles available in plastic or brass.
 Dual nozzle design provides outstanding uniformity.
 Available in colour-coded plastic nozzles for easy and quick cleaning or replacement.

PARTS & ACCESSORIES

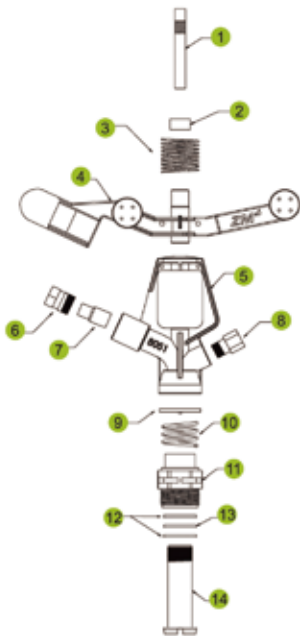

#	Part No.	Material	Qty
1	8051-1	SS304	1
2	8051-2	PE	1
3	8051-3	SS304	1
4	8051-4	POM	1
5	8051-5	POM	1
6	8051-6	BRASS	1
7	8051-7	POM	1
8	8051-8	BRASS	1
9	8051-9	POM	1
10	8051-10	SS304	1
11	8051-11	POM	1
12	8051-12	RUBBER	2
13	8051-13	TEFLON	1
14	8051-14	POM	1

Nozzle specification data sheet

8051 XX XX		
Part No.	Nozzle Size	Nozzle Size
8051	XX	XX
Nozzle Size	Inch	MM
06	3/32"	2.40
08	1/8"	3.20
09	9/64"	3.60
10	5/32"	4.00
11	11/64"	4.30
12	3/16"	4.80
13	13/64"	5.20
14	7/32"	5.60
PG	PLUG	PLUG

PACKAGING

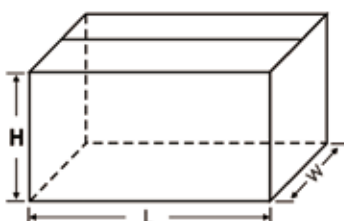

Item#	Qty/ctn	N.W./ctn	G.W./ctn	L x W x H (cm)	M3
ZM8051	50	8.42Kgs	9.05Kgs	40x40x17	0.03



• Performance data

塑料喷头
PLASTIC IMPACT SPRINKLER

Nozzle Size	mm	3.5x2.4mm			4.0x2.4mm			4.4x2.4mm			5.0x2.4mm			5.5x2.4mm		
		Pre.	bar	3.0	4.0	5.0	3.0	4.0	5.0	3.0	4.0	5.0	3.0	4.0	5.0	3.0
Q1	m ³ /h	0.18	0.93	1.02	1.06	1.22	1.35	1.29	1.50	1.65	1.60	1.85	2.10	1.95	2.25	2.50
Q2	m ³ /h	1.16	1.33	1.47	1.41	1.62	1.80	1.64	1.90	2.10	1.95	2.25	2.55	2.30	2.65	2.95
Rad.	m	13.25	13.75	14.00	14.00	14.50	14.75	14.25	15.00	16.50	15.00	16.75	17.00	16.00	17.25	18.00

Nozzle Size	mm	6.0x2.4mm			6.5x2.4mm			6.5x2.4mm			7.0x2.4mm			7.0x2.4mm		
		Pre.	bar	3.0	4.0	5.0	3.0	4.0	5.0	3.0	4.0	5.0	3.0	4.0	5.0	3.0
Q1	m ³ /h	2.3	2.7	3.00	2.7	3.10	3.50	2.70	3.10	3.50	3.30	3.50	3.90	3.30	3.50	3.90
Q2	m ³ /h	2.65	3.10	3.45	3.00	3.45	3.85	3.20	3.70	4.15	3.40	3.90	4.35	3.55	4.10	4.60
Rad.	m	16.50	17.75	18.00	17.00	18.00	19.00	17.00	18.00	19.00	17.00	17.50	18.00	17.10	17.80	18.00



ZM8054



OPERATING RANGE

WORKING PRESSURE: 2.0–3.5 bar
 OW RATE: 0.304–0.904m³/h
 SPRAY RADIUS: 10.00–12.00m.

APPLICATIONS

1.USAGE

Primary applications: under tree, nurseries and greenhouses; designed especially for irrigation of banana plantation.

2.FEATURES

- Single nozzle design
- 14" ideal for undertree irrigation
- Wide range of nozzle and vane combinations for excellent distribution at all pressures
- Built-in hex wrench for easy in-the-field maintenance
- Standard lower bearing pipe thread: 1/2" M NPT or BSP (female also available)
- Flow rates: 1.34 to 3.98 gpm [304 to 904L /hr]
- One-year warranty on materials, workmanship and performance

PARTS & ACCESSORIES

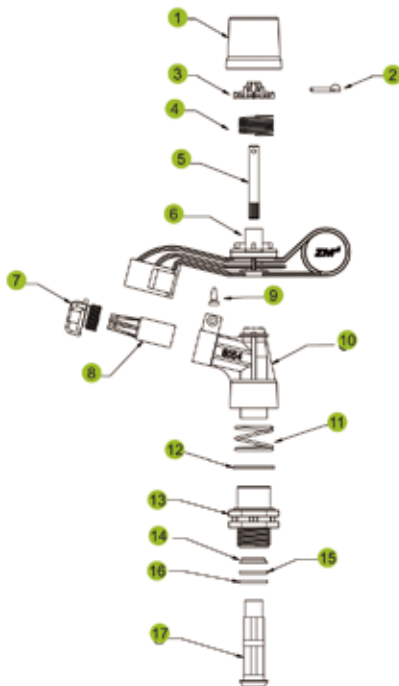

#	Part No.	Material	Qty
1	8054-1	PP	1
2	8054-2	POM	1
3	8054-3	POM	1
4	8054-4	SS304	1
5	8054-5	SS304	1
6	8054-6	POM	1
7	8054-7	POM	1
8	8054-8	RUBBER	1
9	8054-9	RUBBER	1
10	8054-10	POM	1
11	8054-11	POM	1
12	8054-12	SS304	1
13	8054-13	TEFLON	1
14	8054-14	POM	1
15	8054-15	RUBBER	1
16	8054-16	RUBBER	1
17	8054-17	POM	1

Nozzle specification data sheet

8054 XX XX		
Part No.	Nozzle Size	Nozzle Size
8054	XX	XX
Nozzle Size	Inch	MM
06	3/32"	2.40
07	7/64"	2.8
08	1/8"	3.20
09	9/64"	3.60

PACKAGING

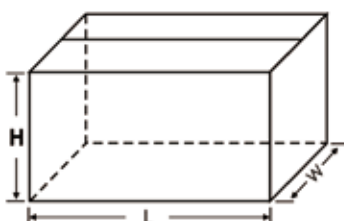

Item#	Qty/ctn	N.W./ctn	G.W./ctn	L x W x H (cm)	M3
ZM8054	50	4.3Kgs	4.7Kgs	49x26x13	0.019



• Performance data

塑料喷头
PLASTIC IMPACT SPRINKLER

Nozzle		#6 2.38mm (3/32") Gold				
Pres	Bar	2.07	2.41	2.76	3.10	3.45
Flow	m ³ /h	0.304	0.329	0.372	0.372	—
Radius	mts.	10.05	10.35	11.00	11.00	—

Nozzle		#7 2.78mm (7/64") Orange				
Pres	Bar	2.07	2.41	2.76	3.10	3.45
Flow	m ³ /h	0.418	0.452	0.481	0.511	10.538
Radius	mts.	10.35	10.70	11.00	11.30	11.45

Nozzle		#8 3.18mm(1/8") Lavender				
Pres	Bar	2.07	2.41	2.76	3.10	3.45
Flow	m ³ /h	0.550	0.595	0.634	0.675	0.709
Radius	mts.	10.70	11.00	11.30	11.60	11.75

Nozzle		#9 3.57mm(9/64") Grey				
Pres	Bar	2.07	2.41	2.76	3.10	3.45
Flow	m ³ /h	0.700	0.756	0.809	0.859	0.904
Radius	mts.	10.35	11.15	11.030	11.75	11.90



ACCESSORIES FOR IMPACT SPRINKLER

Picture	Description	Part No.	Diameter	Units/Box	Picture	Description	Part No.	Diameter	Units/Box
	Agri Connector	2022	1/2" Female	500		Agri-Stand (Without Spike)	2021Kit	1/2" Female 1.3m PVC Pipe	50
	Barb Connector	2023	I.D.:5x8 mm O.D.:8X10 mm	2500		Agri-Stand (With Spike)	2021SPK	1/2" Female 1.3m PVC Pipe 1m Spike	20
	Take Off Connector	2024	I.D.:5x8 mm O.D.:8X10 mm	5000		Adaptor PVC	2032	1/2" X I.D. 25MM	600
	Plug	2025	8 mm	5000		Adaptor PVC	2033	3/4" X I.D. 25MM	600
	Adaptor	2026	1/2" FM X 1/2" FM	600		Adaptor PVC	2034	1/2" X I.D. 34MM	400
	Adaptor	2026M	1/2" M X 1/2" M	600		Adaptor PVC	2035	3/4" X I.D. 34MM	400
	Adaptor	2027	1/2" FM X 3/4" FM	600		Spike zinc alloy	ZSK01	1/2" fm	100
	Adaptor	2028	3/4" FM X 3/4" FM	400					
	Adaptor	2029	3/4" FM X 1" FM	300					
	Adaptor	2030	1/2" FM X 1" FM	250					
	Adaptor	2031	1" FM X 1" FM	200					

Picture	Description	Part No.	Diameter	Units/Box	Picture	Description	Part No.	Diameter	Units/Box
	Rear Nozzle	PRN01XX		5000		Rear Nozzle	PRN02XX		5000
	Main Nozzle	PMN01XX		2500		Rear Nozzle	PRN03XX		5000
	Main Nozzle	PMN02XX		5000		Main Nozzle	PMN01XX		5000
	Rear Nozzle	PRN04XX		10000		Rear Nozzle	BRN01XX		5000
	Main Nozzle	PMN03XX		2500		Rear Nozzle	BRN02XX		2000
	Main Nozzle	PMN04XX		5000		Rear Nozzle	BMN01XX		1000

塑料喷头
PLASTIC IMPACT SPRINKLER



MODULAR GROUP

Complete range of micro-sprinklers and micro-jets

APPLICATIONS

- Irrigation in orchards, vegetables and gardens;
- Irrigation in greenhouses and shade houses;
- Cooling of poultry and livestock.

STRUCTURE AND FEATURES

- Broad range of wetted diameters and flow rates;
- Full-and part-circle patterns;
- Small medium or large droplets produced by different sprayers, swivels or anti-mist devices.

• FEATURES



PERFORMANCE DATA

MODULAR NOZZLE AND FLOWRATE VS PRESSURE

Color	Flow rate (l/h)	Nozzle ID (mm)	Pressure (bar)					
			1.0	1.5	2.0	2.5	3.0	3.5
Violet	35	0.82	25	30	35	39	43	46
Brown	43	0.94	32	37	43	50	55	60
Grey	70	1.16	49	60	70	78	86	93
Green	105	1.41	74	90	105	117	129	139
Orange	120	1.50	85	105	120	134	147	159
Yellow	160	1.73	113	140	160	179	196	212
Blue	200	1.92	141	170	200	224	245	265
Ivory	235	2.07	166	204	235	263	288	311
Red	260	2.18	184	225	260	291	318	344
Black	300	2.34	212	260	300	335	367	397

• 1204A 30cm spike

• 1202

• 1204B 50cm spike

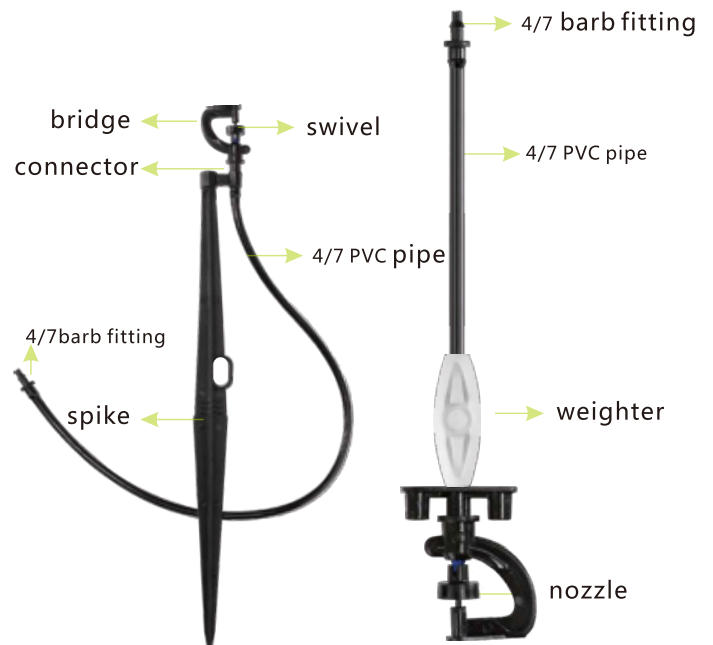

• 1223



• 1220



• 1225



• 1213



• 1219



• 1217



• 1221



• 1218



• 1212



WETTED DIAMETER (M) AT 2.0 BAR AND 0.25M ABOVE GROUND LEVEL

Anti-mist color	Nozzle color	Flow rate (l/h)	Nozzle ID (mm)	Static Spreaders						Swivels				
				90°	180°	Strip	Close range spreader	Flat	12Jet	Small black	Anti-nt	Inverted		
													Height(m)	
	Violet	35	0.82	1.7	2.2	3.2	0.9	2.8	3.4	5.5	6.0	5.0	6.0	
	Brown	43	0.94	1.7	2.5	4.2	0.9	3.4	4.5	5.5	6.0	5.5	6.0	
	Grey	70	1.16	2.5	2.7	8.5	0.9	3.4	5.5	6.0	6.5	6.5	7.5	
	Green	105	1.41	3.5	2.7	9.0	0.9	3.4	6.0	6.0	7.0	8.0	8.5	
	Orange	120	1.5	4.5	2.7	9.0	0.9	4.0	6.0	6.0	7.0	8.0	9.0	
	Yellow	160	1.73							6.5	8.0	9.0	9.5	
	Blue	200	1.92								8.0	9.0	10.0	
	Ivory	235	2.07									9.0	10.5	
	Red	260	2.18									9.0	11.0	
	Black	300	2.34									9.5	11.0	
Green/0.94	Green	40	1.41	2.0	1.2	2.8	0.8	3.5	2.5	4.0		4.5	6.0	
Orange/1.16	Orange	70	1.50	2.2	2.2	5.0	0.8	3.5	4.5	5.0		6.0	7.5	
Yellow/1.40	Yellow	90	1.73	2.5	2.5	5.5	0.9	4.0	5.0	5.5		6.0	8.0	
blue/1.50	Blue	120	1.92	2.5	2.7	7.0	1.0	4.0	6.0	6.0		6.5	8.0	

微喷, 滴头, 连接件
MICRO SPRAYER, DRIPPER,
CONNECTOR



AGRICULTURE & GARDEN

ANTI-ANT "SINGLE-BRIDGE" MINI SPRINKLER

- A series of high performance " single-bridge " mini sprinklers with robust design, a nozzle protection swivel will shut off after operation to prevent insects and dirt from entering the water passages and disturbing regular irrigation.
- The variety of models and flow rates and the uniform distribution covers a wide range o applications

1401



• APPLICATIONS

- The product is designed for irrigation of mature trees with large root zone;
- Due to the high uniformity and large wetting diameter, the emitter can be installed between two trees;
- Good for low precipitation rate and high uniformity overlapping irrigation in greenhouses, flower beds and vegetables;
- Good for frost protection and cooling systems;
- Applicable for parks and home gardens

• TECHNICAL SPECIFICATIONS

Wide range of nozzles to meet all applications , 16-240 liters per hour (0 . 07 - 1.06 gpm);
 Norminal flow rate at 2.0 bar (29 psi);
 Optimal operating pressure range : 1.0-2.5 bar (14 5-36 . 0 psi);
 Large wetting diameter : 5 . 5-10 . m (18-33 Ft);
 Recommended overlapping spacing in wind protected; areas upright position;
 Rectangular spacing up to 6x6 m (20x20 Ft);
 One row of emitters up to 6.0 m (20 Ft) hot house width;
 wo rows of emitters up to 12 m (39 Ft) hot house width;

MAX. WETTING DIAMETER & FLOW RATE AT 2 BAR (29 PSI)

Nozzle Color	Nozzle Diameter		Flow rate		Max. Wetting D at 2 bar	
	(mm)	(inch)	(lph)	(gpm)	m	ft
Light Blue	0.8	0.035	35	0.15	5.7	19
Blue	0.9	0.039	40	0.18	6.1	20
Purple	1.0	0.043	50	0.22	6.8	22
Grey	1.1	0.047	60	0.26	6.9	23
Black	1.2	0.050	70	0.31	8.0	26
Green	1.3	0.055	90	0.39	8.0	26
Orange	1.4	0.058	105	0.46	8.5	28
Red	1.5	0.066	120	0.53	8.9	29
Yellow	1.7	0.070	140	0.62	9.8	32
Brown	1.8	0.071	160	0.70	10.0	33
Dark Blue	2.0	0.078	200	0.88	10.2	33
Dark Green	2.2	0.086	240	1.06	10.4	34

- Recommended Filtration:
 100 mesh for flow rates up to 40 lph, (0.176 gpm);
 80 mesh for flow rates up to 90 lph, (0.396 gpm);
 60 mesh for flow rates up to 240 plh,(1.06 gpm);



ACCESSORIES FOR MICRO SPRAYER/FOGGER

Butterfly Sprayer	(APPLICATION)	(MODELS)
	(Residential / Commercial)	BFS01 / 02 / 03 / 04

BFS:

Inlet size: 1/2"FM or 3/4 FM in same sprinkler

FEATURES

Heavy-duty plastic raw material;
Energy efficient , low-pressure and low flow operation;
Full cirde with bridge moveable design option,
with better uniformity;
Different nozzle size available for different flow;
Combination 1/2 " or 3/4 " female bottom inlet thread;
With spray radius up to 4.5 to 5.0 meters;



- BFS01
- BFS01 N
- BFS01 R



- BFS02
- BFS02 N
- BFS02 R

微噴、滴頭、連接件
MICRO SPRAYER, DRIPPER,
CONNECTOR



AGRICULTURE / GARDEN IRRIGATION MINI-VALVE

“Super C” Mini Valve “Super C” Mini Valve good for all types of irrigation systems;

FEATURES

- Made by durable high quality virgin material;
- Various connection combinations available: Tape connection, Take-off connection, Thread connection, connection with grommet, Lay-flat connection and so on;
- Easy install with Main PVC pipe or PE pipe, with high quality rubber grommet;
- Smooth open and close quarter turn;

• Female thread to tape valve



ITEM NO.	ΦxΦ	PACK
MVTF16012	16X1/2"	50pcs/bag - 500pcs/box

• Bardbed Off-Take PVC Off-Take Valve



ITEM NO	Φ	PACK
MVPR160160	16	50pcs/bag - 400pcs/box

"Super C" Mini Valve "Super C" Mini Valve good for all types of irrigation systems;

FEATURES

- Made by durable high quality virgin material;
- Various connection combinations available: Tape connection, Take-off connection, Thread connection, connection with grommet, Lay-flat connection and so on;
- Easy install with Main PVC pipe or PE pipe, with high quality rubber grommet;
- Smooth open and close quarter turn;

• Barbed Off-Take Valve



ITEM NO.	ΦxΦ	PACK
MVPP160160	16 x 16	50pcs/bag - 500pcs/box
MVPP200200	20 x 20	50pcs/bag - 500pcs/box

• Barbed Off-Take - Female thread Valve



ITEM NO.	ΦxΦ	PACK
MVPF16012	16 x 1/2" FM	50pcs/bag - 500pcs/box
MVPF20012	20 x 1/2" FM	50pcs/bag - 500pcs/box

• Barbed Off-Take gasket for PE pipe Valve



ITEM NO	Φ	⊕	PACK
MVGP160120	16	12	50pcs/bag - 500pcs/box
MVGP200120	20	12	50pcs/bag - 500pcs/box

• Barbed Off-Take-male threaded Valve



ITEM NO	ΦxD"	PACK
MVPM16012	16 x 1/2"	50pcs/bag - 500pcs/box
MVPM16034	16 x 3/4"	50pcs/bag - 450pcs/box
MVPM20012	20 x 1/2"	50pcs/bag - 500pcs/box
MVPM20034	20 x 3/4"	50pcs/bag - 400pcs/box

• Male threaded Off-Take Valve



ITEM NO	D" xD"	PACK
MVMM1212	1/2" x 1/2"	50pcs/bag - 450pcs/box
MVMM3434	3/4" x 3/4"	50pcs/bag - 350pcs/box

• Valve with male-female swivel nut threaded offtakes



ITEM NO	D" xD"	PACK
MVMF1212	1/2" x 1/2"	50pcs/bag - 450pcs/box
MVMF3412	1/2" x 3/4"	50pcs/bag - 350pcs/box

• Tape connector-Barbed Off-Take Valve for LDPE pipe



ITEM NO	Φ	PACK
MVPT160160	16	50pcs/bag - 400pcs/box

• Tape connector-Tape connector Valve



ITEM NO	Φ	PACK
MVTT160160	16	50pcs/bag - 400pcs/box

• Tape connector Off-Take with gasket for PE pipe Valve



ITEM NO	Φ	⊕	PACK
MVTG160120	16	12	50pcs/bag - 400pcs/box

• PVC Off-Take to tape valve



ITEM NO	Φ	⊕	PACK
MVTR160160	16	16	50pcs/bag - 350pcs/box

• Tape connector-male threaded Valve



ITEM NO	D" xD"	PACK
MVMT12160	16 x 1/2"	50pcs/bag - 450pcs/box
MVMT34160	16 x 3/4"	50pcs/bag - 350pcs/box
MVMT12200	22 x 1/2"	50pcs/bag - 300pcs/box
MVMT34200	22 x 3/4"	50pcs/bag - 250pcs/box

• Tape-Plug-in Off-Take Valve for Layflat



ITEM NO	Φ	PACK
MVLT160160	16	50pcs/bag - 400pcs/box

微噴、滴頭、連接件
MICRO SPRAYER, DRIPPER,
CONNECTOR



- Tape connector-Plug-in off-take for Layflat-tape connector / Tee



ITEM NO	ΦxΦxΦ	PACK
TFTTL160160160	16 x16x16	50pcs/bag - 500pcs/box

"Super C" Connector

FEATURES

- Made by durable high quality virgin material;
- Various connection combinations available: Tape connection, Take-off connection, Thread connection, connection with grommet, Lay-flat connection and so on;
- Easy install with Main PVC pipe or PE pipe, with high quality rubber grommet;

• Barbed Off-Take-Tape connector



ITEM NO.	ΦxΦ	PACK
TFTP160160	16 x 16	100pcs/bag - 1000pcs/box

• Tape connector - Male thread



ITEM NO.	ΦxThread	PACK
TFTM16012	16 x 1/2"	100pcs/bag - 1000pcs/box
TFTM160134	16 x 3/4"	100pcs/bag - 1000pcs/box

• Tape connector with gasket for PE / PVC pipe



ITEM NO	Φ	⊕	PACK
TFTR160120	16	12	100pcs/bag - 1000pcs/box

• Tape connector-Plug-in off-take for Layflat



ITEM NO	ΦxΦ	PACK
TFTL160160	16x16	100pcs/bag - 1000pcs/box

• Tape connector-Barbed Off take-Tape connector / Tee



ITEM NO	ΦxΦxΦ	PACK
TTTTP160160160	16X16X16	50pcs/bag - 800pcs/box

• Tape connector-Tape connector-Tape connector / Tee



ITEM NO	ΦxΦxΦ	PACK
TFTTT160160160	16 x16x16	50pcs/bag - 800pcs/box

• Tape connector-Tape connector



ITEM NO	ΦxΦ	PACK
TFTT160160	16 x 16	100pcs/bag - 1000pcs/box

• Tape connector-Grommet to PE / PVC pipe



ITEM NO	Φ	⊕	PACK
TFTP160080	16	8	100pcs/bag - 1000pcs/box

• Tape connector-PE pipe



ITEM NO	Φ	⊕	PACK
TFTT160120	16	12	100pcs/bag - 1000pcs/box

• Tape connector-Tape connector / Elbow



ITEM NO	ΦxΦ	PACK
TFTT160160E	16x16	100pcs/bag - 800pcs/box

• Tape connector-male thread-Tape connector / Tee



ITEM NO	ΦxΦxThread	PACK
TFTTM16016012	16x16x1/2"	50pcs/bag - 800pcs/box
TFTTM16016034	16x16x3/4"	50pcs/bag - 800pcs/box

• Tape -Plug



ITEM NO	Φ	PACK
TFTP16000	16	100pcs/bag - 1500pcs/box

微喷, 滴头, 连接件
 MICRO SPRAYER, DRIPPER,
 CONNECTOR



AGRICULTURE & GREEN HOUSE I-DRIP PRODUCTS



Complete range of I-drip dripper and kit accessories

OAD01



GENERAL INFORMATION

- Ideal for trees, pots and flowers irrigation;
- Can be easily connected with spaghetti hose $\Phi 6$ or with LDPE $\Phi 12$ - $\Phi 32$ for various irrigation patterns;
- Dismantable, removable cap for easy cleaning;
- Adjustable flow rate over a wide pressure range from 0.5 bar

CHARACTERISTICS & FEATURES

- Minimum filtration 80mesh (200micron).
- Signs (+) and (-) for discharge regulating.
- One turn / 16 clicks.
- Safe operation two (2) turns.
- Droplet irrigation < 14 l/h.
- "Umbrella" irrigation > 14 l/h.
- Minimum radius at 1.0 bar is 5cm.
- Maximum radius at 1.0 bar is 40cm.
- Eight (8) irrigation grooves.

OAD-01 PERFORMANCE DATA (0-70 L/H)

TYPE	0.5 bar		1.0 bar		1.5 bar		2.0 bar		2.5 bar		3.0 bar	
	L/H	GPM	L/H	GPM	L/H	GPM	L/H	GPM	L/H	GPM	L/H	GPM
CLICK												
2	3.9	0.017	9.2	0.040	11.9	0.052	14.5	0.064	16.9	0.074	19.5	0.086
4	6.9	0.030	11.1	0.049	14.7	0.065	17.1	0.075	19.6	0.086	22.3	0.098
8	10.1	0.044	16.1	0.071	22.6	0.099	25.0	0.110	28.4	0.125	32.3	0.142
12	19.1	0.084	29.5	0.130	39.8	0.175	44.8	0.197	50.9	0.224	56.7	0.249
16	25.3	0.111	39.3	0.173	52.2	0.233	59.7	0.263	67.2	0.296	75.5	0.332
20	29.8	0.131	45.7	0.201	61.2	0.269	69.0	0.304	78.1	0.344	88.0	0.387
24	34.7	0.152	52.6	0.231	70.1	0.308	78.5	0.345	89.5	0.394	100.3	0.441
28	40.0	0.176	59.4	0.261	78.7	0.346	88.0	0.387	99.6	0.438	112.0	0.493
32	44.2	0.194	66.7	0.293	88.5	0.389	98.6	0.434	112.1	0.493	125.5	0.552

AMS001



FLOW RATE DATA

0-260L/H



AGRICULTURE & GARDEN & GREEN HOUSE A-DRIP PRODUCTS



• DAAS01 • DASS01

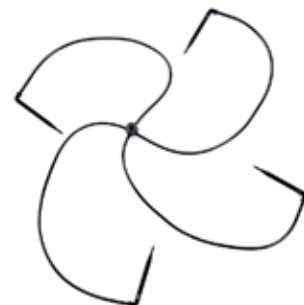

A-DRIP : ARROW DRIPPER

APPLICATIONS:

Greenhouses, nurseries, garden pot irrigation.

SPECIFICATIONS:

- Maximal working pressure: 1.2 bar.
- "Turbulent" labyrinth wide water passages for highest reliability and efficiency.
- 5 different models to meet growers' requirements.

FEATURES & BENEFITS:

- Allows placement of drippers exactly where necessary.
- Allows maximum flexibility in greenhouse and nurseries (with soft PE micro- tubes).
- Allows installation of other drippers to add compensated and anti-drain

TECHNICAL DATA

Flow rate (l/h)*	Maximum working pressure (bar)	Water passages dimensions Width-depth-length (mm.)	Filtration area (mm ²)	Constant K	Exponent X
1.6	1.2	0.83 x 0.60 x 20	9.4	0.551	0.48
2.3	1.2	0.83 x 0.86 x 20	12.6	0.761	0.48

* Flow rate at 1.0 bar pressure.

** Arrow dripper at 1.6 l/h. nominal flow rate, only available in the angle model.

PACKAGING DATA

DESCRIPTION	QUANTITY / BOX UNITS	BOX DIMENSIONS CM x CM x CM	BOX WEIGHT KGS (AVERAGE)
Black 2.3 l/h. angle	1250	57 x 28 x 27	4.0
Gray 2.3 l/h. angle	1250	57 x 28 x 27	4.0
Gray 1.6 l/h. angle	1250	57 x 28 x 27	4.0
Black 2.3 l/h. angle short	3000	57 x 28 x 27	5.7
Gray 2.3 l/h. angle short	3000	57 x 28 x 27	5.7
Black 2.3 l/h. straight	4000	57 x 28 x 27	9.8
Black 2.3 l/h. straight + splitter	4000	57 x 28 x 27	10.4
Gray 2.3 l/h. straight + splitter	4000	57 x 28 x 27	10.4
Black 2.3 l/h. straight + plug	8500	57 x 28 x 27	5.3

微噴, 滴頭, 連接件
 MICRO SPRAYER, DRIPPER,
 CONNECTOR



AGRICULTURE & GARDEN & GREEN HOUSE FLAG DRIPPERS

FLAG DRIPPER

Flag Drip Emitters

DIG's FN Flag Drip Emitters have a unique style with a side barbed outlet extension for extending 1/4" micro tubing to the plant area. They are available in flow rates of 1, 2 and 4 GPH and operate at 10 to 25 PSI with the flow rate depending on the incoming inlet pressure. The nominal pressure for the flag drip emitters is 15 PSI. With higher pressure, the drip emitters will release more flow, and with lower pressure, less flow. They are available in packs of 5, 25 and 100, all with a 1/4" self-tapping barbed inlet and 1/4" small barbed outlet. The emitters have a take-apart two-piece construction, so that the top insert can be twisted and pulled apart for easy cleaning. Use these emitters in small systems with short run plantings, on flat terrain and with low pressure gravity feed systems.

Features

- Available in three colors so that it is easy to identify flow rate
- Self-tapping barbed inlet for easy installation
- Outlet barb for use with 1/4" micro tubing
- Spiral flow through a large-flow-path water passage reduces likelihood of clogging
- Twist-open top with lock for secure operation under pressure and for easy cleaning
- Durable high-impact plastic
- Resistant to chemicals and fertilizers used in landscape application
- Constructed of UV-resistant, durable plastic material to withstand the most adverse conditions

Product Specifications

- Operating pressure range: 10 to 25 PSI
- Recommended operating pressure: 25 PSI (use with model D46 25-PSI pressure regulator)
- Flow rates and color codes:
 - 1 GPH (4 L/H) color code – black
 - 2 GPH (8 L/H) color code – green
 - 4 GPH (12 L/H) color code – red
- Inlet side: 1/4" self-tapping barb
- Outlet side: 1/4" barb
- Filter requirement: minimum of 150 mesh
- Material: body and cover: polypropylene





• OFD-04



Flow rate in gallons per hour @ 5 to 30 PSI

Color	Black	Green	Red
Nominal flow rate	1 GPH	2 GPH	4 GPH

Color	Black	Green	Red
5 PSI	.5	.77	1.72
10PSI	.79	1.21	2.81
15 PSI	1	1.61	3.61
20 PSI	1.22	1.95	4.29
25 PSI	1.39	2.19	4.92
30 PSI	1.55	2.44	5.51

• OFD-08



Maximum number of 1 GPH black drip emitters on 1/2" drip tubing with .600 ID

Drip emitters spacing	1'	2'	3'	4'
Flow rate @ 25 PSI	1.39	1.39	1.39	1.39
Maximum length	124	192	249	304
Flow rate in GPM	2.87	2.22	1.92	1.76
Flow rate in GPH	172.4	133.4	115.4	105.6
# of drip emitters	124	96	83	76
Velocity (f/s)	3.26	2.52	2.18	2.0
Total head loss in PSI	5.5	5.19	5.05	5.23

Maximum number of 2 GPH green drip emitters on 1/2" drip tubing with .600 ID

Drip emitters spacing	1'	2'	3'	4'
Flow rate @ 25 PSI	2.19	2.19	2.19	2.19
Maximum length	91	144	186	224

• OFD-16



Drip emitters spacing	1'	2'	3'	4'
Flow rate in GPM	3.32	2.63	2.26	2.04
Flow rate in GPH	199.3	157.7	135.8	122.6
# of drip emitters	91	72	62	56
Velocity (f/s)	3.77	2.99	2.57	2.32
Total head loss in PSI	5.2	5.22	5.09	5.07

Maximum number of 4 GPH red drip emitters on 1/2" drip tubing with .600 ID

Drip emitters spacing	1'	2'	3'	4'
Flow rate @ 25 PSI	4.29	4.29	4.29	4.29
Maximum length	59	94	120	148
Flow rate in GPM	4.22	3.36	2.86	2.65
Flow rate in GPH	253.1	201.6	171.6	158.7
# of drip emitters	59	47	40	37
Velocity (f/s)	4.79	3.81	3.25	3.01
Total head loss in PSI	5.1	5.38	5.02	5.31

*Based on around 90% flow uniformity and 0% slop

微喷、滴头、连接器
MICRO SPRAYER, DRIPPER,
CONNECTOR



AGRICULTURE & GARDEN & LANDSCAPE SUPER FITTINGS

APPLICATIONS

- 17 mm fits driplines, and PE irrigation hose with inside diameters of 14.2mm and 15.2mm;
- 12 mm fits PE irrigation hose with inside diameters of 10.8mm;

SPECIFICATIONS

- Maximum recommended system pressure (without clamps) : 3.45 bar;
- Acceptable hose inside diameter for 17mm fittings: 14.2mm - 15.2mm;
- Acceptable hose inside diameter for 12mm fittings: 10.8mm;

FEATURES & BENEFITS

- BARBED FITTINGS: For secure fit and easy installation without clamps, glue or tools;
- UV RESISTANT: Withstands heat, direct sun and harsh chemicals;
- ONE-PIECE CONSTRUCTION: For added strength, durability and long-term performance;
- ALLOWS FOR EASY ON-SITE INSPECTION: For proper fitting and installation;



INSERT COUPLING
CODE : SF17COUP



INSERT ADAPTER
CODE: SF17IAPVC-B



INSERT TEE
CODE: SF17ITEE



INSERT ELBOW
CODE: SF17IELB



INSERT CROSS
CODE: SF17ICRO



GROMMET ELBOW
CODE: SF17ICELB



1/2" MPT ADAPTER
CODE: SF17050MA



3/4" MPT ADAPTER
CODE: SF17075MA



1/2" MPT ELBOW
CODE: SF17050ELB



3/4" MPT ELBOW
CODE: SF17075ELB



1/2" FM THREADED TEE
CODE: SF17050FTEE



3/4" FM THREADED TEE
CODE: SF17075FTEE



3/4" FPT x THREE WAY
CODE: SF17075FTW



PLUG 17MM
CODE: SF17PLUG

16mm PP



INSERT ADAPTER
CODE: SF16IAPVC-B



INSERT ELBOW
CODE: SF16IELB



INSERT COUPLING
CODE: SF16COUP



INSERT TEE
CODE: SF16ITEE



1/2" M ADAPTER
CODE: SF16050MA



3/4" M ADAPTER
CODE: SF16075MA



PLUG 16MM
CODE: SF16PLUG



ACCESSORIES FOR IRRIGATION SYSTEM FITTINGS / SIMPLE TOOLS / MICRO TUBE

Picture	Description	Part No.	Size	Units/Box	Picture	Description	Part No.	Size	Units/Box
	1/4" LONG TRANSFER BARBS	MIC-001	1/4"	10000		BUTTERFLY CONNECTOR	MIC-011	4 x 7 mm	10000
	Two Way Connector	MIC-002	4 x 7 mm	10000		Reuger	MIC-010	4mmX1/2"m	5000
	1/4" GOOF PLUGS FOR REPAIR (TWO WAY)	MIC-003	1/4"	10000		Fogger	1216-3		5000
	1/4" BARBED TEE	MIC-004	1/4"	10000		Micro tube 3x5 mm	MT-35	3x5mm	500m
	1/4" BARBED ELBOW	MIC-005	1/4"	10000		Micro tube 4x7 mm	MT-47	4x7mm	500m
	1/4" BARBED CROSS	MIC-006	1/4"	10000		CONNECTOR	MIC-023	4x7mm	
	Barb Connector	MIC-007	4 x 7 mm I.D.6.0mm	20000		CONNECTOR	MIC-016	3x5mm	
	Barb Connector	MIC-008	4 x 7 mm O.D.6.0mm	20000		CONNECTOR	MIC-024	4x7mm I.D.5.9mm	
	Three Way Connector	MIC-009	4 x 7 mm	10000		CONNECTOR	MIC-025	4 x 7 mm	
	BARB CONNECTOR FOUR WAY FOR MICRO TUBE 3 x 5.5 mm	MIC-017	4mm x 1/2"	5000		CONNECTOR	MIC-026	4x7mm O.D.5.9mm	
	CONNECTOR	MIC-022	4/7mm			CONNECTOR	MIC-027	3 x 5mm	
	CONNECTOR	PNA01	1/2"fm			CONNECTOR	MIC-028	3 x 5mm	

微喷、滴头、连接件
MICRO SPRAYER, DRIPPER,
CONNECTOR

FOGGER

- Filtration requirements: 130microns(120mesh)
- Minimum height above crop: 1.0m
- Max. spacing between units on laterals : 1.2m
- Max. spacing between lateral : 1.2m

■ 1201

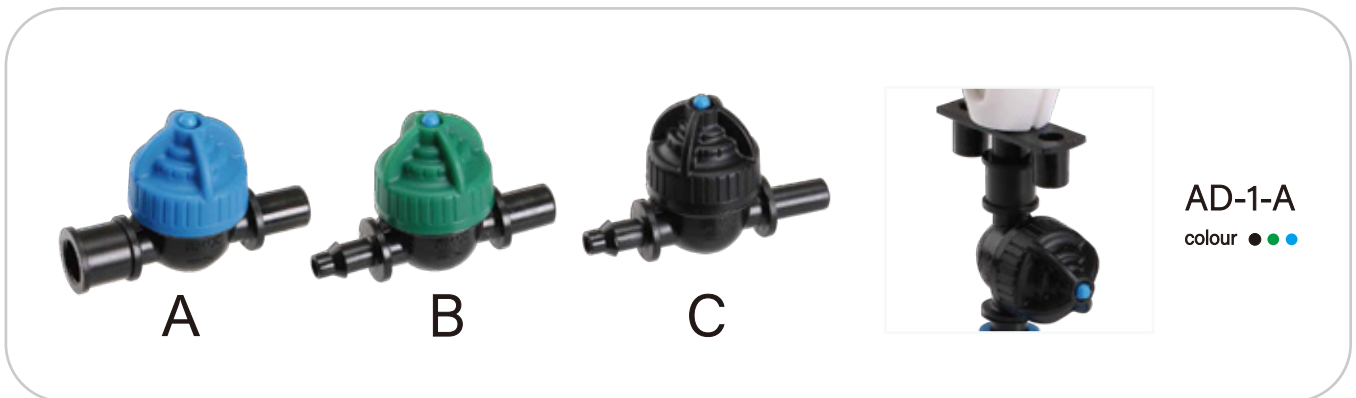
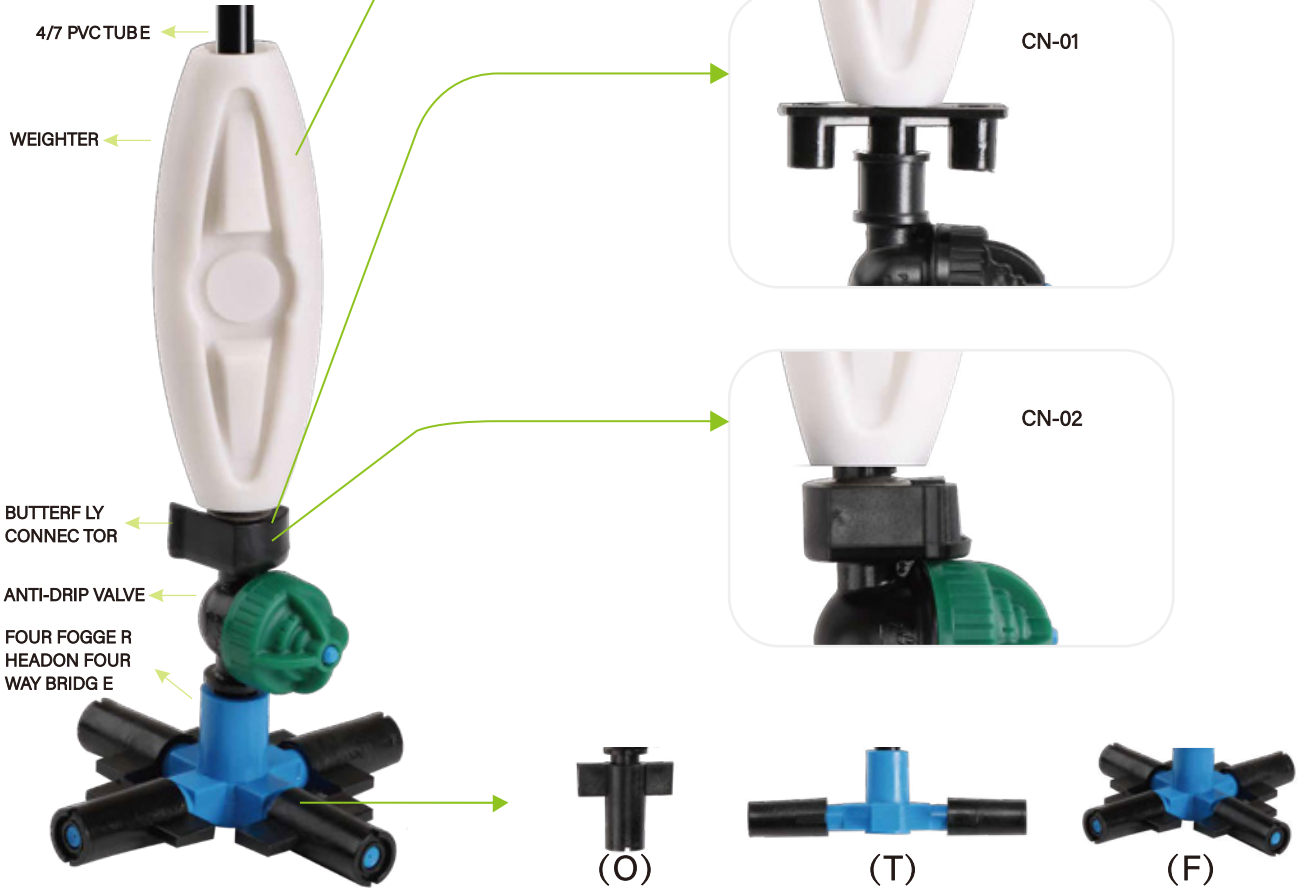

FOGGER FLOW RATE ON CROSS (l/h)

Nozzle Color	Violet	Blue	Orange	Red	Black
3.0 bar	18.0	24.0	48.0	72.0	96.0
4.0 bar	21.2	28.0	56.0	84.0	112.0

OPERATING PRESSURE (bar)		
	Opening	Closure
Low-Pressure Super LPD	1.4	0.6
Medium-Pressure Super LPD	3.0	1.5
High-Pressure Super LPD	4.0	2.4



GARDEN & LANDSCAPE
POP-UP IMPACT ROTOR



POP-UP IMPACT ROTOR

GARDEN & LANDSCAPE



SRPIR01

Inlet size: 1/2" or 3/4" Female

SUPER RAIN	APPLICATION	MODELS
	Residential/Commercial	SRPIR01

FEATURES

- Heavy-duty plastic case with sturdy, reinforced ribbed design.
- Double-weighted arm for slower rotation and increased distance of throw.
- Self-flushing inner trip with improved inner trip lever.
- Energy efficient, low-pressure and low-gallage operation.
- Full-circle or adjustable arc 20° to 340°.
- Distance controller diffuser pin.
- FP trip for full- or part-circle operation.
- Inlet screen filter.
- Side inlet installation is not recommended in freezing climates;
- Multi-function, pressure-activated wiper seal.
- Combination 1/2" or 3/4" female bottom inlet.



Performance data

Nozzle Size	mm	2.8 (Orange)			3.0 (Red)			3.2 (Green)			4.5 (Blue)			4.0 (Black)		
		2.0	3.0	4.0	1.0	2.0	3.0	1.0	2.0	3.0	1.0	2.0	3.0	1.0	2.0	3.0
Pre.	bar	2.0	3.0	4.0	1.0	2.0	3.0	1.0	2.0	3.0	1.0	2.0	3.0	1.0	2.0	3.0
Flow Rate	m ³ /h	0.45	0.55	0.63	0.36	0.51	0.63	0.41	0.57	0.70	0.49	0.66	0.81	0.60	0.85	1.03
Rad.	m	11.0	11.5	12.0	9.50	11.5	12.0	10.0	11.5	12.0	10.0	11.5	12.0	10.5	12.0	13.0

SPECIFICATION

型号规格 SUPER RAIN MODELS	额外选择 OPTIONS
SRPIR0107=WITH 7/64" NOZZLE / 2.8MM NOZZLE	(blank)= No option
SRPIR0107*=WITH 0.118" NOZZLE / 3.0MM NOZZLE	
SRPIR0108=WITH 1/8" NOZZLE / 3.2MM NOZZLE	
SRPIR0109=WITH 9/64" NOZZLE / 3.5MM NOZZLE	
SRPIR0110=WITH 5/32" NOZZLE / 4.0MM NOZZLE	

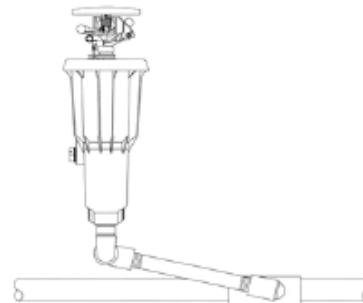

园林灌溉-地理喷头
POP-UP SPRINKLER



ACCURATE - SPRAY	ACCURATE-SPRAY	APPLICATION	MODELS
		Residential	5cm, 10cm, 15cm



• FEATURES

- Application: Residential
- Models: 5cm, 10cm, 15cm
- Nozzle choices: 5
- Flow rate: 0.04 to 1.22 m³/hr
- Nozzle choices: 3.0m, 3.7m, 4.6m, 5.2m ,1.5x9.1m side strip (side strip pattern available on 5 and 10cm models only)
- Warranty period: 1 year

• OPERATING SPECIFICATIONS

- Flow rate: 0.63 to 20.4 l/min
- Radius: 2.5 to 5m
- Recommended pressure range:1.4 to 4.8 bar; 140 to 480 kPa
- Precipitation rates: 43mm/ hr approx.

SPECIFICATION

MODELS	RADIUS
ACC-02=5cm(2") pop-up ACC-04=10cm(4") pop-up ACC-06=15cm(6") pop-up	10AN=3.0m(10') adjustable nozzle 12AN=3.7m(12') adjustable nozzle 15AN=4.6m(15') adjustable nozzle 17AN=5.2m(17') adjustable nozzle 5SSN=1.5mx9.0m(5'X30) side strip (5cm and 10cm only)

■ EXAMPLES

ACC-04-15AN	10 cm(4") pop-up, with a 4.6m (15') adjustable nozzle
ACC-06-10AN	15 cm(6") pop-up, with a 3.0m (10') adjustable nozzle



POP-UP SPRINKLER

PANDA-SPRAY	(APPLICATION)	(MODELS)
	(Residential/Commercial)	(Shrub), 5cm, 7.5cm, 10cm, 15cm, 30cm



PAN00
Inlet size: 1/2"Female



UNI-S01-XXAN
Overall height: 15.5cm
Pop up height: 10cm
Exposed diameter: 5.7cm
Inlet size: 1/2"Female



PAN02
Overall height: 10cm
Pop up height: 5cm
Exposed diameter: 5.7cm
Inlet size: 1/2"Female



PAN03
Overall height: 12.5cm
Pop up height: 7.5cm
Exposed diameter: 5.7cm
Inlet size: 1/2"Female



PAN04
Overall height: 15.5cm
Pop up height: 10cm
Exposed diameter: 5.7cm
Inlet size: 1/2"Female



PAN06
Overall height: 22.5cm
Pop up height: 15cm
Exposed diameter: 5.7cm
Inlet size: 1/2"Female



PAN12
Overall height: 41cm
Pop up height: 30cm
Exposed diameter: 5.7cm
Inlet size: 1/2"Female

FEATURES

- Application: Residential/commercial
- Models: Shrub, 5cm, 7.5cm, 10cm, 15cm, 30cm
- No side inlet (NSI) version available in 15 cm and 30 cm
- Warranty period: 2 years

SPECIFICATION

STANDARD MODELS	OPTIONS	EXAMPLES
PAN-00=Shrub adapter	(blank)= No option	
PAN-02= 5 cm(2") pop-up	CV= Factory-installed drain check valve (pop-up models only)	PAN-04-10AN 10 cm(4")pop-up, and 10A nozzle
PAN-03= 7.5cm(3")pop-up	CV-R= Factory-installed reclaimed body cap (shrub molded in purple)	PAN-06-CV-12HN 15 cm (6 ") pop-up , drain check valve , and 12H nozzle
PAN-04= 10cm(4")pop-up	15cm and 30cm models ordered as CV will come as no side inlet	PAN-12-CV-R-RCS 30 cm(12")pop-up, drain check valve, reclaimed body cap, and right corner strip
PAN-06= 15cm(6")pop-up		
PAN-06-NSI= 15cm(6")pop-up with no side inlet		
PAN-12= 30cm(12") pop-up		
PAN 12 NSI= 30cm(12") pop up with no side inlet		

园林灌溉-地理喷头
POP-UP SPRINKLER

PANDA-PRS30	(APPLICATION)	(MODELS)
	(Residential/Commercial)	(Shrub),10cm,15cm,30cm



PAN04-PRS30
 Overall height: 15.5cm
 Exposed diameter: 5.7cm
 Inlet size: ½" Female

• **FEATURES**

- Application: Residential/commercial
- Models: Shrub, 10cm, 15cm, 30cm
- No side inlet (NSI) version available in 15 cm and 30 cm
- Warranty period: 2 years

PAN30 MODELS (formerly Institutional Spray)	OPTIONS	■ EXAMPLES						
PAN-00-PRS30=2.1 bar regulated shrub adapter PAN-04-PRS30=2.1 bar regulated 10cm(4") pop-up PAN-06-PRS30=2.1 bar regulated 15cm(6") pop-up PAN-06-NSI-PRS30=2.1 bar regulated 15cm(6") pop-up with no side inlet PAN-12-PRS30=2.1 bar regulated 30cm(12") pop-up PAN-12-NSI-PRS30=2.1 bar regulated 30cm(12") pop-up with no side inlet	(blank)= No option CV= Factory-installed drain check valve (pop-up models only) CV-R= Factory-installed drain check valve and reclaimed body cap(shrub molded in purple) 15cm and 30cm models ordered as CV will come as no side inlet	<table border="1"> <tr> <td>PAN-04-PRS30</td> <td>10 cm (4") pop-up regulated at 2.1 ba</td> </tr> <tr> <td>PAN-06-PRS30-CV-12HN</td> <td>15 cm (6") pop-up regulated at 2.1 bar , drain checkvalve and 12HN nozzle</td> </tr> <tr> <td>PAN-12-PRS30-CV-R-10AN</td> <td>30 cm (12") pop-up regulated at 2.1 bar, drain checkvalve, reclaimed body cap , and 10AN nozzle</td> </tr> </table>	PAN-04-PRS30	10 cm (4") pop-up regulated at 2.1 ba	PAN-06-PRS30-CV-12HN	15 cm (6") pop-up regulated at 2.1 bar , drain checkvalve and 12HN nozzle	PAN-12-PRS30-CV-R-10AN	30 cm (12") pop-up regulated at 2.1 bar, drain checkvalve, reclaimed body cap , and 10AN nozzle
PAN-04-PRS30	10 cm (4") pop-up regulated at 2.1 ba							
PAN-06-PRS30-CV-12HN	15 cm (6") pop-up regulated at 2.1 bar , drain checkvalve and 12HN nozzle							
PAN-12-PRS30-CV-R-10AN	30 cm (12") pop-up regulated at 2.1 bar, drain checkvalve, reclaimed body cap , and 10AN nozzle							

PANDA-PRS40	(APPLICATION)	(MODELS)
	(Residential/Commercial)	(Shrub),10cm,15cm,30cm



PAN04-PRS40
 Overall height: 15.5cm
 Exposed diameter: 5.7cm
 Inlet size: ½" Female

• **FEATURES**

- Application: Residential/commercial
- Models: Shrub,10cm, 15cm, 30cm
- No side inlet (NSI) version available in 15 cm and 30 cm
- Warranty period: 2 years

PRS40 MODELS (formerly MPR40)	OPTIONS
PAN-00-PRS40=2.8 bar regulated shrub adapter PAN-04-PRS40-CV=2.8 bar regulated 10cm(4") pop-up PAN-06-PRS40-CV=2.8 bar regulated 15cm(6") pop-up PAN-12-PRS40-CV=2.8 bar regulated 30cm(12") pop-up	(blank)= No option R= Factory-installed reclaimed body cap 15cm and 30cm models will come as no side inlet

■ **EXAMPLES**

PAN-04-PRS40	10 cm(4")pop-up regulated at 2.8 bar
PAN-06-PRS40-CV-12HN	15 cm(6") pop-up regulated at 2.8 bar, and drain check valve, and 12HN nozzle
PAN-12-PRS40-CV-R-10AN	30 cm(12") pop-up regulated at 2.8 bar, drain check valve, and reclaimed body cap,and 10AN nozzle

LPS ADJUSTABLE NOZZLES

FEATURES

- Colour - coded for easy field identification
- Designed with large water droplets to withstand light winds
- Even distribution results in beautiful pattern
- New 1.2 m and 1.8 m Pro Adjustable Nozzles provide additional flexibility
- Easy grip top to simple adjustment
- Adjustable from 0° to 360°
- Recommended operating pressure: 2.1 bar, 210kPa

LPS Standard Nozzles Performance Data-Metric

Arc	Pressure Bar	kPa	1.2 m Radius Adjustable from 0° to 360° Trajectory: 0° Color Code: Lt.Green					1.8 m Radius Adjustable from 0° to 360° Trajectory: 0° Color Code: Lt.Blue				
			Radius m	Flow m ³ /hr	Flow l/min	Precip ■	mm/hr ▲	Radius m	Flow m ³ /hr	Flow l/min	Precip ■	mm/hr ▲
45°	1.0	100	0.9	0.02	0.27	162	187	1.5	0.02	0.37	79	91
	1.5	150	0.9	0.02	0.34	202	234	1.5	0.03	0.46	98	113
	2.0	200	1.2	0.02	0.40	133	154	1.8	0.03	0.54	80	92
	2.1	210	1.2	0.02	0.41	137	158	1.8	0.03	0.55	82	95
	2.5	250	1.2	0.03	0.45	151	174	1.8	0.04	0.61	90	104
90°	1.0	100	0.9	0.03	0.55	162	187	1.5	0.04	0.74	79	91
	1.5	150	0.9	0.04	0.68	202	234	1.5	0.06	0.92	98	113
	2.0	200	1.2	0.05	0.80	133	154	1.8	0.06	1.08	80	92
	2.1	210	1.2	0.05	0.82	137	158	1.8	0.07	1.11	82	95
	2.5	250	1.2	0.05	0.90	151	174	1.8	0.07	1.22	90	104
120°	1.0	100	0.9	0.04	0.73	162	187	1.5	0.06	0.98	79	91
	1.5	150	0.9	0.05	0.91	202	234	1.5	0.07	1.23	98	113
	2.0	200	1.2	0.06	1.07	133	154	1.8	0.09	1.44	80	92
	2.1	210	1.2	0.07	1.10	137	158	1.8	0.09	1.48	82	95
	2.5	250	1.2	0.07	1.21	151	174	1.8	0.10	1.62	90	104
180°	1.0	100	0.9	0.07	1.09	162	187	1.5	0.09	1.47	79	91
	1.5	150	0.9	0.08	1.37	202	234	1.5	0.11	1.84	98	113
	2.0	200	1.2	0.10	1.60	133	154	1.8	0.13	2.16	80	92
	2.1	210	1.2	0.10	1.64	137	158	1.8	0.13	2.21	82	95
	2.5	250	1.2	0.11	1.81	151	174	1.8	0.15	2.44	90	104
240°	1.0	100	0.9	0.09	1.46	162	187	1.5	0.12	1.96	79	91
	1.5	150	0.9	0.11	1.82	202	234	1.5	0.15	2.45	98	113
	2.0	200	1.2	0.13	2.13	133	154	1.8	0.17	2.87	80	92
	2.1	210	1.2	0.13	2.19	137	158	1.8	0.18	2.95	82	95
	2.5	250	1.2	0.14	2.41	151	174	1.8	0.19	3.25	90	104
270°	1.0	100	0.9	0.10	1.64	162	187	1.5	0.13	2.21	123	91
	1.5	150	0.9	0.12	2.05	202	234	1.5	0.17	2.76	98	113
	2.0	200	1.2	0.14	2.40	133	154	1.8	0.19	3.23	80	92
	2.1	210	1.2	0.15	2.47	137	158	1.8	0.20	3.32	82	95
	2.5	250	1.2	0.16	2.71	151	174	1.8	0.22	3.66	90	104
360°	1.0	100	0.9	0.13	2.19	162	187	1.5	0.18	2.94	123	91
	1.5	150	0.9	0.16	2.73	202	234	1.5	0.22	3.68	98	113
	2.0	200	1.2	0.19	3.20	133	154	1.8	0.26	4.31	80	92
	2.1	210	1.2	0.20	3.29	137	158	1.8	0.27	4.43	82	95
	2.5	250	1.2	0.22	3.62	151	174	1.8	0.29	4.87	90	104

Note: The Pro-Spray PR530's built-in pressure regulator controls output to a maximum of 2.1 bar(210 kPa).Optimum nozzle performance shown in bold.



园林灌溉-地理喷头
POP-UP SPRINKLER



GARDEN & LANDSCAPE ACCESSORIES FOR POP-UP IRRIGATION SYSTEM

Picture	Description	Part No.	Size	Units /Box	Picture	Description	Part No.	Size	Units /Box
	Plastic QCV Key	2124-1	3/4" Male	200		Plastic Elbow	PSAC-01	Φ16mm X 1/2" M	
							PSAC-02	Φ16mm X 3/4" M	
	Plastic QCV Body	2124-2	1" Female	50		Plastic Elbow	PSAC-03	Φ16mm X 1/2" M	500
							PSAC-04	Φ16mm X 3/4" M	
	Plastic QCV Body	2126	1 1/2" Female	40		Plastic Elbow	PSAC-05	1/2" Female X 1/2" Male	
	Brass QCV Key	2120B-1	1/2" Female X 3/4" Male	20		Plastic Elbow	PSAC-06	3/4" Female X 3/4" Male	
	Brass QCV Body	2120B-2	3/4" Female	20		Swing Joint	SJ-01	1/2" Male X 1/2" Male	100
						Swing Joint	SJ-02	3/4" Male X 3/4" Male	100
	Brass QCV Key	2125B-1	1" Male	20		Swing Joint	SJ05	1/2" Male X 1/2" Male	100
						Swing Joint	SJ06	3/4" Male X 3/4" Male	100
	Brass QCV Body	2125B-2	1" Female	10		Swing Joint	SJ0506	1/2" Male X 3/4" Male	100

园林灌溉-地理喷头
POP-UP SPRINKLER



IRRIGATION & CONSTRUCTION SUPER CLAMP SADDLE

SUPER CLAMP SADDLE WITHOUT / WITH REINFORCING RING

CODE (WITHOUT)	CODE (WITH)	d x G	L	H	E	F	n	PN
51032002	53032002	32x 1/2"	52	24	80	64	4	16
51032003	53032003	32x 3/4"	46	18	80	64	4	16
51040002	53040002	40x 1/2"	51	17	87	74	4	16
51040003	53040003	40x 3/4"	53	20	87	74	4	16
51040004	53040004	40x1"	60	21	87	74	4	16
51050002	53050002	50x 1/2"	65	24	102	78	4	16
51050003	53050003	50x 3/4"	66	26	102	78	4	16
51050004	53050004	50x1"	65	24	102	78	4	16
51063002	53063002	63x 1/2"	70	24	116	88	4	16
51063003	53063003	63x 3/4"	86	23	116	88	4	16
51063004	53063004	63x1"	58	20	116	88	4	16
51063005	53063005	63x1 1/4"	70	26	116	88	4	16
51063006	53063006	63x1 1/2"	63	28	116	88	4	16
51075002	53075002	75x 1/2"	81	25	130	88	4	16
51075003	53075003	75x 3/4"	81	26	130	88	4	16
51075004	53075004	75x1"	80	26	130	88	4	16
51075005	53075005	75x1 1/4"	81	26	130	88	4	16
51075006	53075006	75x1 1/2"	80	26	130	88	4	16
51075007	53075007	75x2"	84	30	130	88	4	16

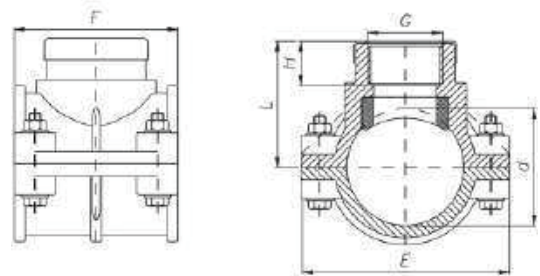

SUPER DOUBLE CLAMP SADDLE WITH REINFORCING RING PN16

CODE (WITHOUT)	CODE (WITH)	d x G	L	H	E	F	n	PN
52032002	54032002	32x 1/2"	52	24	80	64	4	16
52032003	54032003	32x 3/4"	46	18	80	64	4	16
52040002	54040002	40x 1/2"	51	17	87	74	4	16
52040003	54040003	40x 3/4"	53	20	87	74	4	16
52040004	54040004	40x1"	60	21	87	74	4	16
52050002	54050002	50x 1/2"	65	24	102	78	4	16
52050003	54050003	50x 3/4"	66	26	102	78	4	16
52050004	54050004	50x1"	65	24	102	78	4	16
52063002	54063002	63x 1/2"	70	24	116	88	4	16
52063003	54063003	63x 3/4"	86	23	116	88	4	16
52063004	54063004	63x1"	58	20	116	88	4	16
52063005	54063005	63x1 1/4"	70	26	116	88	4	16
52063006	54063006	63x1 1/2"	63	28	116	88	4	16
52075002	54075002	75x 1/2"	81	25	130	88	4	16
52075003	54075003	75x 3/4"	81	26	130	88	4	16
52075004	54075004	75x1"	80	26	130	88	4	16
52075005	54075005	75x1 1/4"	81	26	130	88	4	16
52075006	54075006	75x1 1/2"	80	26	130	88	4	16
52075007	54075007	75x2"	84	30	130	88	4	16

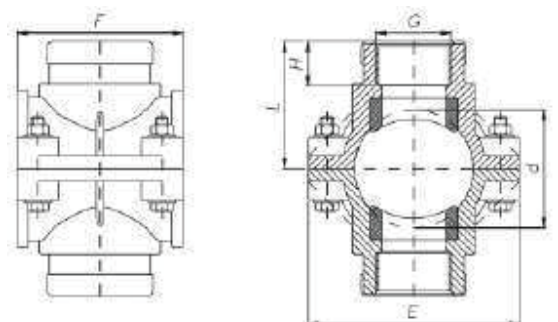

鞍座
SADDLE CLAMP



余姚市阳光雨人灌溉设备厂

地址：浙江省余姚市丈亭镇龙南村油车桥12号

YUYAO XINTUO IRRIGATION EQUIPMENT CO. ,LTD.

YUYAO SUN-RAINMAN IRRIGATION EQUIPMENT FACTORY

ADD: Youche Qiao #12, Longnan Village, ZhangtingTown, Yuyao , Zhejiang , China

TELL: 0086-574-6298-3163

FAX: 0086-574-6298-3828

更多产品信息登陆:

www.inovato-zm.com

www.zmirrigation.com